

WIN £600 OF PRIZES! PLUS YARNS, PATTERNS & MORE

AUG 2015

For knitters just like you

Knit today

78+ PROJECTS & IDEAS

- ◆ Adorable baby knits
- ◆ Quick accessories
- ◆ Must-try exclusives

Knit it in one night!

ALL DESIGNS sizes 8-22

16 EXCITING MAKES FOR EVERYONE

IMMEDIATE MEDIA ^{CO} ISSUE 114 AUG 2015

HOW TOs

GET NEATER SHAPING + KNITTING IN THE ROUND



READER STORY

'I'M ALLERGIC TO WOOL!'



HOT SUMMER LOOKS you'll love!

INTRODUCING...

THE WORLD'S FASTEST KNITTER!



LOVE FAMILY FUN

Thousands of new
patterns for the
whole family

LoveKnitting.com
0845 544 2196

Enter code **LOVEKT20**
at LoveKnitting.com
to get 15% off your order.

Debbie Bliss
Rialto DK Prints
by Debbie Bliss



Yarn, Needles, Buttons, Books, Patterns, Kits and Accessories

WorldMags.net



Hello



Look out for this pretty girls' cardi next issue!



Suddenly the sun is out and all things seem **bright and beautiful**. Even rainy days are filled with buds, blossoms – and the season's hot new knitwear colours and styles! Keep that fresh feeling with your pick of the delectable projects in this issue. Top of my list is Sirdar's exclusive **coral cardigan** on page 7, to give my summer gatherings a little zing. I love

Louisa Harding's vest on page 66 too – perfect bohemian chic, whatever your age! Rowan's denim tee on page 29 is another crowd pleaser to see you through the summer in style. For a **quick knit**, cast on a headband (p34) or dinosaur toy (p23). Happy holidays!



This month I love...

Bumbling bees

Our office is buzzing about this knitted hive at the Shipley Gallery (p14)



This month I want...

Karenza & Co cushions

These were made to go together! But at £27.50 each, it wouldn't be cheap to fill my sofa. Could I work out a knitting pattern...

Rosee

Rosee, Editor



Follow us on Facebook /KnitToday



Follow us on Twitter /KnitToday



Follow us on Pinterest /knittoday



Follow us on Instagram /knittoday magazine

FREE DIGITAL TRIAL!

p20

Subscribe today...

Get a free one month trial* to the digital edition of *Knit Today!*

*After your one month trial your subscription will continue at £2.99 per month

your pics

We love seeing pics of all the gorgeous projects you've made. Share yours on our Facebook page today!



Pull the other one! This really is the door bell, honest



69



43



29



85



74



13

All the latest news and products from the knitting world



60

this month...

PATTERNS

- 07 Coral cardigan**
Created exclusively for *Knit Today* in cool cotton, this cardigan is ideal for sunny days
- 23 Cuddly dinosaur toys**
This trio of prehistoric pals from Angela Turner are smiley rather than snarly
- 29 Denim blue tee**
Lace sleeves set this knitted t-shirt apart from the crowd
- 34 Lace headband**
Turn heads with Jacqui Harding's plummy headband

- 37 Cropped girls' jumper**
A natural finish in subtle stripes make this a knit little girls will love to wear
- 43 Rico beach coverup**
Keep the sun off in style with this button-front cardigan in self-patterning cotton
- 53 Baby booties & mittens**
Keep baby snugly warm with this gorgeous knitted set in sweet pink from Phildar
- 60 Rainbow socks**
Love your feet with these beautifully fancy socks

- 66 Designer vest**
Louisa Harding's summer vest is knitted in the round
- 69 Playtime sailor suit set**
Kit out a little sailor in classic nautical style with this onsie and booties set from Sublime
- 74 Belle bow bag**
Work simple stitches in baby blue to make this season's essential knitted tote
- 79 Casual men's jumper**
Classic style for him worked in a mix of stocking, garter and lace stitches

REVIEWS

- 42 Pattern reviews**
Our selection of the best new designs, as well as essential downloads to bookmark for a rainy day
- 47 Great reads**
There are plenty of new knit and crochet titles to enjoy this month, plus the best bloggers in yarncraft
- 58 Yarn reviews**
Knitting for a baby? Try one of these super-soft yarns to make sure they stay comfy



win
OVER £600
 worth of prizes!
 TURN TO PAGE 78

07

This oh-so-pretty lace knit bolero will see you through the summer in enviable style

KNIT TODAY PROMISE

- ◆ **KNITS FOR EVERY SHAPE AND BUDGET**
 Our exclusive women's patterns are sized 8 to 22 as a minimum, but usually go up to a size 26, with yarn alternatives too. Where we feature pattern extracts we endeavour to include as wide a range of sizes as possible.
- ◆ **CLEARLY WRITTEN, ACCURATE PATTERNS**
 Our patterns are triple-checked and clearly laid out. Got a query? Just email patternhelp@immediate.co.uk
- ◆ **ON-TREND PATTERNS FOR EVERY SKILL LEVEL**
 Anyone, from a beginner to a life-long knitter, can find something great to make in *Knit Today*.

FEATURES

- 49 The perfect finish**
Knit Today's editor, Rosee Woodland shares her expertise for neat knits
- 56 Cast on for charity**
 Bonnie Babies sends crafted clothes to premature babies – could you help their work?
- 63 Knitting with a wool allergy**
 There are plenty of non-wool options for sensitive skins
- 82 Introducing Hazel Tindell**
 Spend the afternoon with the queen of Fair Isle knitting

REGULARS

- 13 Knit news**
 Knitting innovations and essential events plus all the latest products and patterns
- 18 In style**
 Nautical looks are big news on the knitting high seas!
- 40 Hi there!**
 Peek in our postbag
- 76 Ask the experts**
 Our trio of knitters have the solution for every problem
- 78 Giveaways**
 £610 worth of prizes to win!

- 84 Puzzles**
 Pit your wits to win a prize!
- 89 Back issues**
 Missed an issue? Find it here
- 90 How to knit**
 A handy step-by-step guide
- 92 Abbreviations**
 For all this month's patterns
- 93 Stockists**
 For the yarn in this issue
- 97 Next month**
 What's coming up...
- 98 Back chat**
 Meet Benedict, our new man

M&S

EST. 1884

The official partner
of the World's Biggest
Coffee Morning

CAKE
TASTES
BETTER
TOGETHER

Get together for a great cause

Share a slice of something nice at home or at work
on **Friday 25 September** and raise some
money to help people facing cancer. Get your
fabulous free Macmillan Coffee Morning Kit.

Text **CREAM9** to **70550**
or visit macmillan.org.uk/coffee



FREE CAKE
STENCIL



WE ARE
MACMILLAN.
CANCER SUPPORT

SKILL LEVEL



INTERMEDIATE

TECHNIQUES

- ◆ SIMPLE LACE
- ◆ BUTTONHOLES

EXCLUSIVE
KNIT TODAY PATTERN

Dress it up in cool coral!

Knit this gorgeous, short-sleeved cardigan in the coolest coral cotton Exclusively by **Sirdar** for **Knit Today**



"Feeling creative? Swap the buttonhole and button for an inch-wide shiny ribbon in a pink shade!"



ROSEE, EDITOR

Enjoy pure versatility

when you create this soft, summer cardigan. Quick to knit (with all the lovely lacy detail kept neatly at the bottom) you could whip it up in all the colours of the rainbow, matching every summer dress you own! A simple single fastening means you don't have to splash out on haberdashery and you get to show off your pretty summer dress or top underneath!

Materials

- ◆ Yarn
5 (5:6:8:9:10) x 50g balls of Sirdar Beachcomber DK F099 in Coral Bay (shade 256).
- ◆ Needles
1 pair of 4mm (UK 8, US 6) knitting needles
1 pair of 3¼mm (UK 10, US 3) knitting needles
4mm (UK 8, US 6) 80cm

circular knitting needle if required
◆ Accessories
Stitch holders and a button

Yarn detail

- ◆ Sirdar Beachcomber DK
www.sirdar.co.uk
01924 371501
- ◆ 100% cotton
- ◆ 50g/153m (140 yards)
- ◆ Machine wash at 30°
- ◆ £2.85

Tension

22 sts and 28 rows to 10cm or 4in measured over st st on 4mm needles.

Special abbreviations

- p2sso** pass 2 slipped stitches over
- sl2tog** insert right-hand needle into fronts of next 2 sts as if to k2tog, do not knit these sts together but slip both sts together onto right hand needle

◆ Turn to page 92 for full list of abbreviations

BACK AND FRONTS

Worked in one piece to armholes. Using 4mm needles or 4mm circular needle if required and thumb method, cast on 231 (253:275:297:319:341) sts loosely.

Row 1 (RS): K6, *yfwd, k9, sl2tog, k1, p2sso, k9, yfwd, k1, rep from * to last 5 sts, k5.

Row 2 (WS): K5, p2, *k19, p3, rep from * to last 26 sts, k19, p2, k5.

Row 3: K5, slip these 5 sts onto a safety pin, k2, *yfwd, k8, sl2tog, k1, p2sso, k8, yfwd, k3, rep from * to last 26 sts, yfwd, k8, sl2tog, k1, p2sso, k8, yfwd, k2, slip rem 5 sts onto a safety pin. 221 (243:265:287:309:331) sts

Row 4: P3, *k17, p5, rep from * to last 20 sts, k17, p3.

Row 5: K3, *yfwd, k7, sl2tog, k1, p2sso, k7, yfwd, k5, rep from * to last 20 sts, yfwd, k7, sl2tog, k1, p2sso, k7, yfwd, k3.

Row 6: P4, k15, *p7, k15, rep from * to last 4 sts, p4.

Row 7: K4, *yfwd, k6, sl2tog, k1, p2sso, k6, yfwd, k7, rep from * to last 19 sts, yfwd, k6, sl2tog, k1, p2sso, 6, yfwd, k4.

Row 8: P5, k13, *p9, k13, rep from * to last 5 sts, p5.

Row 9: K5, *yfwd, k5, sl2tog, k1, p2sso, k5, yfwd, k9, rep from * to last 18 sts, yfwd, k5, sl2tog, k1, p2sso, k5, yfwd, k5.

Row 10: P6, k11, *p11, k11, rep from * to last 6 sts, p6.

Row 11: K6, *yfwd, k4, sl2tog, k1, p2sso, k4, yfwd, k11, rep from * to last 17 sts, yfwd, k4, sl2tog, k1, p2sso, k4, yfwd, k6.

Row 12: P7, k9, *p13, k9, rep from * to last 7 sts, p7.

Row 13: K7, *yfwd, k3, sl2tog, k1, p2sso, k3, yfwd, k13, rep from * to last 16 sts, yfwd, k3, sl2tog, k1, p2sso, k3, yfwd, k7.

Row 14: P8, k7, *p15, k7, rep from * to last 8 sts, p8.

Row 15: K8, *yfwd, k2, sl2tog, k1, p2sso, k2, yfwd, k15, rep from * to last 15 sts, yfwd, k2, sl2tog, k1, p2sso, k2, yfwd, k8.

Row 16: P9, k5, *p17, k5, rep from * to last 9 sts, p9.

Row 17: K9, *yfwd, k1, sl2tog, k1, p2sso, k1, yfwd, k17, rep from * to last 14 sts, yfwd, k1, sl2tog, k1, p2sso, k1, yfwd, k9.

Row 18: P10, k3, *p19, k3, rep from * to last 10 sts, p10.

Row 19: K10, *yfwd, sl2tog, k1, p2sso, yfwd, k19, rep from * to last 13 sts, yfwd, sl2tog, k1, p2sso, yfwd, k10.

Row 20: P11, k1, *p21, k1, rep from * to last 11 sts, p11.

Row 21: K4 (10:16:6:16:2), k2tog, (k12 [15:19:19:23:23], k2tog) 15 (13:11:13:11:13) times, k5 (10:16:6:16:2).

SIZING GUIDE		8-10	12-14	16-18	20-22	24-26	28-30
TO FIT BUST	cm	81-86	91-97	102-107	112-117	122-127	132-137
	in	32-34	36-38	40-42	44-46	48-50	52-54
ACTUAL BUST	cm	88	99	110	119	130	139
	in	34¾	39	43¼	47	51¼	54¾
FULL LENGTH	cm	48	50	54	58	62	64
	in	19	19¾	21¼	22¾	24½	25¼
SLEEVE LENGTH	cm	0.5	0.5	0.5	0.5	0.5	0.5
	in	¼	¼	¼	¼	¼	¼

205 (229:253:273:297:317) sts

Row 22: Purl.

ST ST BODY

Proceed as follows:

Row 1 (RS): Knit.

Row 2 (WS): Purl.

These 2 rows will now be referred to as st st. Working in st st throughout, work 8 rows more.

Next row (RS): K49 (55:61:66:72:77), k2tog, k1, sl1, k1, pss0, k97 (109:121:131:143:153), k2tog, k1, sl1, k1, pss0, k49 (55:61:66:72:77).

201 (225:249:269:293:313) sts

Work 19 (19:21:23:25:25) rows more without shaping.

Next row (RS): K48 (54:60:65:71:76), k2tog, k1, sl1, k1, pss0, k95 (107:119:129:141:151), k2tog, k1, sl1, k1, pss0, k48 (54:60:65:71:76).

197 (221:245:265:289:309) sts

Work 19 (19:21:25:27:27) rows more without shaping.

Next row: K47 (53:59:64:70:75), k2tog, k1, sl1, k1, pss0, k93 (105:117:127:139:149), k2tog, k1, sl1, k1, pss0, k47 (53:59:64:70:75).

193 (217:241:261:285:305) sts

Cont without shaping until work meas 29 (29:31:33:35:35) cm, 11½ (11½:12:13:13¾:13¾) in, ending with a WS row.

DIVIDE FOR BACK AND FRONTS

Next row (RS): K46 (52:58:63:69:74), k2tog, slip these 47 (53:59:64:70:75) sts just worked onto a stitch holder for right front, k2tog, k93 (105:117:127:139:149), k2tog, slip these 95 (107:119:129:141:151) sts just worked onto a stitch holder for back, k2tog, k46 (52:58:63:69:74).

LEFT FRONT

Working on the first 47 (53:59:64:70:75) sts only, proceed as follows:

SHAPE ARMHOLE

Next row: Purl to last 2 sts, p2tog (armhole edge). 46 (52:58:63:69:74) sts

Work 7 (8:10:12:14:15) rows dec 1 st at armhole edge in every row.

39 (44:48:51:55:59) sts

Cont without shaping until armhole measures 8 (9:10:12:14:16) cm, 3 (3½:4:4¾:5½:6¼) in, ending with a RS row.

SHAPE NECK

Next row (WS): Cast off 4 sts, purl to end. 35 (40:44:47:51:55) sts

Next row (RS): Knit to last 2 sts, k2tog. 34 (39:43:46:50:54) sts

Next row: Cast off 2 (2:2:2:3:3) sts, purl to



end. 32 (37:41:44:47:51) sts

Row 4: Knit to last 2 sts, k2tog.

31 (36:40:43:46:50) sts

For 1st size only

Rep row 3 once. 29 sts

For 2nd, 3rd and 4th sizes only

Rep rows 3 and 4 once. (33:37:40) sts

Work (1:0:0) row dec 1 st at neck edge.

(32:37:40) sts

For 5th and 6th sizes only

Next row: Cast off 2 sts, purl to end.

(44:48) sts

For 3rd, 4th, 5th and 6th sizes only

Work (1:3:4:8) rows dec 1st at neck edge in every row. (36:37:40:40) sts

For all 6 sizes

Work 11 (9:5:7:3:3) rows dec 1 st at neck edge only on next and every foll alt row.

23 (27:33:33:38:38) sts

Work 4 (4:12:8:12:8) rows dec 1 st at neck

edge in every foll 4th row.

22 (26:30:31:35:36) sts

Cont without shaping until armhole

measures 19 (21:23:25:27:29) cm,

7½ (8¼:9:9¾:10¾:11½) in, ending with a WS row.

SHAPE SHOULDER

Next row (RS): Cast off 11 (13:15:15:17:18)

sts, knit to end. 11 (13:15:16:18:18) sts



Prefer a plain edge? Knit the first 22 rows in 1 x 1 rib for a simpler knit

Next row: Purl.

Cast off rem 11 (**13:15:16:18:18**) sts.

BACK

With WS facing, rejoin yarn to 95 (**107:119:129:141:151**) sts left on a stitch holder for back and proceed as follows:

SHAPE ARMHOLES

Work 8 (**9:11:13:15:16**) rows dec 1 st at each end of every row. 79 (**89:97:103:111:119**) sts
Cont without shaping until armholes measure 19 (**21:23:25:27:29**) cm, 7½ (**8¼:9:9¾:10¾:11½**) in, ending with a WS row.

SHAPE SHOULDERS

Cast off 11 (**13:15:15:17:18**) sts at beg of next 2 rows. 57 (**63:67:73:77:83**) sts
Cast off 11 (**13:15:16:18:18**) sts at beg of next 2 rows. 35 (**37:37:41:41:47**) sts
Cast off rem 35 (**37:37:41:41:47**) sts.

RIGHT FRONT

With WS facing rejoin yarn to 47 (**53:59:64:70:75**) sts left on a stitch holder for right front and proceed as follows:

SHAPE ARMHOLE

Next row (WS): P2tog (armhole edge), purl to end. 46 (**52:58:63:69:74**) sts
Work 7 (**8:10:12:14:15**) rows dec 1 st at armhole edge in every row.
39 (**44:48:51:55:59**) sts
Cont without shaping until armhole measures 8 (**9:10:12:14:16**) cm, 3 (**3½:4:4¾:5½:6¼**) in, ending with a WS row.

SHAPE NECK

Row 1 (RS): Cast off 4 sts, knit to end. 35 (**40:44:47:51:55**) sts
Row 2 (WS): Purl to last 2 sts, p2tog. 34 (**39:43:46:50:54**) sts
Row 3: Cast off 2 (**2:2:2:3:3**) sts, knit to end. 32 (**37:41:44:47:51**) sts
Row 4: Purl to last 2 sts, p2tog. 31 (**36:40:43:46:50**) sts

For 1st size only

Rep 3rd row once. 29 sts
Work 1 row more without shaping.

For 2nd, 3rd and 4th sizes only

Rep 3rd and 4th rows once. (**33:37:40**) sts

For 5th and 6th sizes only

Next row: Cast off 2 sts, knit to end. (**44:48**) sts

For 4th, 5th and 6th sizes only

Work (**2:3:7**) rows dec 1 st at neck edge in

every row. (38:41:41) sts

For all 6 sizes

Work 11 (11:7:9:5:5) rows, dec 1 st at neck edge only in next and every foll alt row.

23 (27:33:33:38:38) sts

Work 4 (4:12:8:12:8) rows dec 1 st at neck edge in every foll 4th row.

22 (26:30:31:35:36) sts

Cont without shaping until armhole measures 19 (21:23:25:27:29) cm, 7½ (8¼:9:9¾:10¼:11½) in, ending with a RS row.

SHAPE SHOULDER

Next row: Cast off 11 (13:15:15:17:18) sts, purl to end. 11 (13:15:16:18:18) sts

Next row: Knit.

Cast off rem 11 (13:15:16:18:18) sts.

SLEEVES (BOTH ALIKE)

Using 4mm needles and thumb method cast on 70 (74:84:92:96:102) sts.

Row 1 (RS): Knit.

This row will now be referred to as g st (garter stitch).

Work 1 row more in g st.

Working in st st throughout proceed as follows:

SHAPE SLEEVE TOP

Work 9 (10:12:14:16:17) rows, dec 1 st at each end of every row.

52 (54:60:64:64:68) sts

Work 1 (0:0:0:0:1) row more without shaping.

Cast off 2 (1:1:2:1:1) sts at beg of next

18 (2:2:20:12:8) rows. 16 (52:58:24:52:60) sts

For 2nd, 3rd, 4th, 5th and 6th sizes only

Cast off (2:2:3:2:2) sts at beg of next

(18:20:2:16:20) rows. (16:18:18:20:20) sts

For all 6 sizes

Cast off rem 16 (16:18:18:20:20) sts

LEFT FRONT BORDER

Using 3¼mm needles cast on 1 st (cast on st to be used for sewing border to front), with RS facing, knit across 5 sts left on safety pin. 6 stsz

Cont in g st until border is long enough to go up left front to neck edge when slightly stretched, ending with a WS row. Leave these sts on a safety pin.

RIGHT FRONT BORDER

Using 3¼mm needles cast on 1 st (cast on st to be used for sewing border to front), with WS facing, knit across 5 sts left on a safety



Sirdar Beachcomber DK gives a beautifully soft, uneven slub texture



Fold sleeves in half before inserting into the main body of the cardi

pin. 6 sts

Cont in g st until border is 2 rows less than left front border, ending with a WS row.

Next row: K3, yfwd, k2tog, k1.

Work 1 row in g st.

Do not break off yarn, leave these sts on a spare needle, or stitch holder.

NECK BORDER

Join shoulder seams. With RS facing, using 3¼mm needles knit across 6 sts left on a needle for right front border, pick up and knit 38 (38:42:42:42:42) sts evenly along right side of neck, 35 (37:37:41:41:47) sts from cast off sts at back of neck, 38 (38:42:42:42:42) sts evenly along left side

of neck and knit across 6 sts left on a safety pin for left front border.

123 (125:133:137:137:143) sts

Row 1: Knit.

Work 1 row more in g st.

Cast off knitways.

TO MAKE UP

Fold the sleeves in half lengthways then, placing folds to shoulder seams, sew sleeves in position neatly. Join the sleeve seams. Sew on the button. To block the garment pin it out to the measurement given on page 8. Cover the garment with damp cloths and leave until completely dry. 

Three Bags Full™



We aim to offer a fast, friendly and generally fabulous service, both online and in our Halifax shop.

Stocking loads of lovely yarns from Yorkshire and around the world...

Debbie Bliss, Artesano, Wendy, Peter Pan, Crystal Palace, Fiberspates, Patons, Cygnet, Adriafl, Bergere, Noro and West Yorkshire Spinners... plus patterns, needles and accessories.

The Old Bank, Silver Street, Halifax

07941133155 | threebagsfullwoolshop@googlemail.com | www.threebagsfulluk.com

Specialising in knitting yarn & accessories

Remember When

80 High Street, Coleshill, West Midlands B46 3AH
T: 01675 466418

We stock Araucania, Bergere de France, Colinette, Lion Brand, Debbie Bliss, King Cole, Louisa Harding, Noro, Adriafl, Rico, Rowan, Sirdar, Stylecraft, James C. Brett, Wendy

A friendly welcome awaits you!

www.rememberwhenshop.co.uk

Postal service available

10% off Rowan Quote KT

Mandy Wools



Traditional Wool Shop and Haberdashery

We Stock Yarns and Patterns From:

Adriafl, Debbie Bliss,
James C Brett, Jenny Watson,
Katia, King Cole,
Opal, Sirdar
Stylecraft, Tivoli,
Wendy, Woolcraft.

We also stock a large range of ribbons, bindings, braids, zips, buttons and hundreds of other items.

Visit Us Online

www.mandywools.co.uk

Or in our Shop

5 Mill Street, Wells, BA5 2AS
01749 677548



Upcoming Workshops

Beginners Crochet

Saturday 4th July 2015: 2-4pm
£25.00 includes materials

Tunisian Crochet:

Saturday 11th July 2015: 2-4pm
£25.00 includes materials

For more information or to book a place, please visit our shop or ring us on 01462 612889. £10 deposit required.

01462 612889

www.wool-n-things.co.uk

wool-n-things@hotmail.co.uk

3-5 Hitchin Street, Baldock, Herts, SG7 6AL



Great value & superb quality



“Everybody’s knitting!”

Focus on Spring, here are some of the ideal yarns, we offer stock service at sensible prices:



Just a small part of our huge cone and ball range.

DK Panama 50 cot/50 ac; 15 colours

DK soft cotton 4pl Soft cotton 16 colours NEW!

Cannele 4 ply mercerised corded cotton; 51 colours

Panama 4 ply 50 cot/50 ac; 30 colours

Perle 4 ply soft mercerised cotton NEW! 18 colours

4 ply soft cotton 15 colours NEW!

Call or email for these FREE! cards showing the actual yarn not photocopies. Please let us know if you are a hand, or machine knitter, or crochet-er...thankyou.

yeoman-yarns.co.uk

YEOMAN YARNS Ltd; Kibworth, Leics LE8 0RX Tel: 0116 240 4464
E: sales@yeomanyarns.co.uk W: www.yeoman-yarns.co.uk

Be Creative
with YEOMAN YARNS

We only make and source yarn ethically and within UK & Europe.



P14

GNOME TIME
What do you get when you cross an ambitious bunch of amateur knitters with a travelling yarn exhibition? An epic knit garden!



P15

TOTES AMAZEBALLS
Declare your love for craft when you are out and about with one of these decorative canvas totes for knitters and crafters.



P16

CRAFT & CARE
New designs from Manos del Uruguay can link you to the cooperative of craftspeople who created the yarn you love.

knitting news

There's plenty to get excited about in the fabulous world of wool this month!

A GRAND DAY OUT

Following his close shave, a super-sized Shaun has been bedecked in three-dimensional freestyle crochet by artist Vicky Harrison of Paper Village Arts. She's created the sculpture as part of the Shaun in the City trail that will see 70 decorated Shauns around Bristol from 6 July to Monday 31 August, before being auctioned to raise money for The Grand Appeal charity. Her giant crochet Shaun will be on display in St Nicholas market throughout the event.

Vicky used about 30 techniques to create her Woolly Wonderland sculpture. "My Shaun sculpture took 561 hours to make – a real crochet marathon," says Vicky. "I made him to show the versatility of crochet and how it can be developed. I love the fact that you can work in any direction and use any kind of yarn. I want him to inspire people to crochet and to experiment."

✦ For more information about Shaun in the City, visit www.shauninthecity.org.uk



want more?
See more woollen art on page 14!





BLOOMIN' MARVELLOUS

Back in 2010 Pauline Stanley and her fellow Bloomin Marvellous project participants picked up their needles to start work on a community project to create a knitted garden that would be exhibited in Bournemouth central library for four weeks in May 2011. Lots of local and non-local people, school children, craft groups and shops got involved knitting and crocheting pieces for the project, donating yarn – we even ran a story about the project in Knit Today so that our readers could get involved too!

It took three days to install in its first home, but was a massive success, complete with knitted pond, flowers and gnome-filled beds, potting shed, veggies, birds insects and animals aplenty – even a washing line strewn with knitted smalls! Over 30,000 people saw the garden in its original home, and it even attracted yarn bombers, with a knitted dog poo placed next to the dog on the lawn.

After its initial success the garden started touring the local area, which then led to it embarking on a three year countywide tour, with many new knits added by local groups as the garden bloomed in their area, including a knitted picnic, green house and bird table.

The garden is spending spring/summer 2015 at Shipley gallery in Gateshead Newcastle, on display until 5 September. Entry is free, and the gallery is open from 10am-4pm Tuesday- Saturday. So if the weather is bad, you can still come and enjoy this bright knitted garden, guaranteed to raise a smile, whatever the weather.

✦ www.twmuseums.org.uk/shipley-art-gallery/



4 OF OUR FAVE KNITTED DINOSAURS



Photography by Holly Jolliffe

1 For a menagerie of prehistoric knitted pals, look out for Knit Your Own Dinosaur by Sally Muir and Joanna Osborne. Due to be published in July 2015, the book contains 12 realistic knitting patterns for £12.99 from Pavilion. tinyurl.com/qgnskja

2 Cats are cool, but cats in hats are cooler, and cats in dinosaur hats are the coolest of all. Sara Thomas's book Cats in Hats: 30 Knit and Crochet Patterns for Your Kitty published by Running Press in March 2015 contains an amazing cat Stegosaurus bonnet, well worth the £9.99 book price alone. tinyurl.com/p5gdd8u

3 With the Peter Pan dinosaur sweater and toy pattern (P1146) you get two pals for the price of one, with designs for both a Triceratops knitted toy and T-Rex jumper. Download it for £2.49. tinyurl.com/qffjvt7

4 If you're eager to let your knitting needles lose on a dinosaur project today, you're in luck! Just turn to **page 23** and you can choose from a stripy Stegosaurus, Triceratops or a Corythosaurus designed fabulously by Angela Turner!

3 of the best

COTTON YARNS

It's called cotton fresh for a reason! Keep your summer knits cool with one of these cotton or cotton mix yarns



✦ **King Cole Cottonsoft DK**
These chunky balls are perfect for your everyday summer knits in a good range of colours.
100% cotton, £4.49 per (210m/229yds) 100g ball



✦ **Rowan Softknit Cotton DK**
Perfect for showing off cables, this soft drape yarn gives great definition in a dreamy finish.
92% cotton, 8% polyamide, £5.99 per (105m/114yds) 50g ball



✦ **James C Brett Cotton On DK**
You can use this cotton mix yarn for your year-round knits in a selection of fun, vibrant shades.
50% cotton, 50% acrylic, £1.99 per (145m/158yds) 50g ball



This gorgeous Summer Feeling dress from Garn Studio's Drops design 160 range has a touch of Ibiza about it – the classical white island style rather than the clubbing scene. With its lace pattern back and decorated raglan sleeves, this is simply sensational summer wear.
www.garnstudio.com

SNIPPETS

Yarn Yoshi

Nintendo are developing a new game featuring cute dragon Yoshi – in wool! Yoshi's Woolly World will have a knitted and handcrafted finish, so the development team made real items using wool to test the representations in the game. Yoshi just got even cuter



Not so fleeced

Australian wool prices have risen by 15 per cent following widespread drought in Eastern Australia, and increased buying from China giving the industry a much needed boost. The UK wool price is likely to remain stable.



diary dates

JULY 21

Natural Fibre Company open days
 Unit B Pipers Court Pennygillam Way, Launceston, Cornwall
 Meet the animals that produce the yarn and visit the spinning mill that processes wool, mohair and alpaca yarns for specialist producers
www.thenaturalfibre.co.uk

JULY 22

Purl Alpaca knitting workshop
 Burwash Manor, Barton, Cambridge
 Take your pick from Purl Alpaca's kit designs plus five balls of yarn to use with them, plus expert tuition, meet the alpacas, eat lunch, tea and biscuits, all for just £99.
www.purlalpacadesigns.com

JULY 24

Anniken Allis Continental knitting workshop
 Spin a Yarn, Bovey Tracey, Devon
 Learn to carry your yarn in your left hand and knit continental style, the continental long-tail cast on and the Norwegian purl. The day costs £49 including lunch and teatime treats.
www.spinayarndevon.co.uk

JULY 25-26

Fibre East
 Redborne Community College, Bedford
 Celebrating the finest quality British wool made from the fleeces of British sheep reared by British farmers to enable the continuation of the crafts.
www.fibre-east.co.uk



Three of a kind

TOTES FOR KNITTERS

♥ LOUD AND PROUD

We love this colourful canvas tote, covered with all manner of crafting paraphernalia in delightfully bright illustrations, for £8.50
www.lauraleedesigns.co.uk



♥ MAKE A STATEMENT

Available in a choice of colourways, you can use this tote to store your stash or just your shopping as you declare your knit love to the world, for £14.
www.berryred.co.uk



♥ YARN FORWARD

We also like big skeins and hanks! Raise a smile with this monochrome tote for £13.75 by Kelly Conner designs
www.notonthehighstreet.com

This fab new yarn has all the softness and appeal of Rico Baby with a great colour variation to give a self patterning finish to all your baby knits, available in six toning colourways.
Rico Baby So Soft Print DK
 100% acrylic, 250m/273yds per 100g, £3.99





without having to leave the area they live in to find work. It helps the women, and keeps traditional techniques alive.

Each handcrafted skein is unique with the subtle irregularities that the hand of each artisan gives to it – every skein has a tag signed by the artisan who made it and the cooperative's location, to connect the knitter to these people. The kettle-dyeing process used in Manos Serena gives the colors a heathered, stonewashed look, reflecting the story of each garment – a vision in the new shades of glacier and tide blues, burnt orange zinnia and boysenberry.

✦ www.roosteryarns.com

HANDS UP FOR MANOS SERENA

Rooster are introducing seven new pattern leaflets of sumptuous designs supporting the new colours of Manos del Uruguay's Manos Serena yarn, introduced earlier this year. With their laidback, fashion-forward style these are no ordinary knitting patterns. But then, this is no ordinary yarn either! Manos Serena is a spectacular summer weight yarn with an amazing drape in 60% cotton and 40% baby alpaca, but it's the heritage of this yarn that really sets it apart. The yarn is made as part of a social project to provide rural women with jobs in their hometowns, established more than 45 years ago. The artisans work in cooperatives to spin and dye the yarn, earning a Fair Trade wage to support themselves and their families

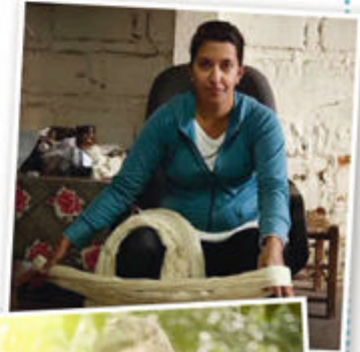

knit I, purrrrr-I I

Cats and craft don't always go together, but here is one puss who won't make a mess of your balls of yarn. Instead, she's busy knitting an extra long sock to keep her tail cosy! This artisan greetings card is created by MillionMilesCards, using vintage artwork from maker Poppy's grandfather, John Miles, drawn in the 1970s. The card is blank inside for your own message, so perfect to send to any cat loving crafter to make them smile, and costs £2.50.

www.etsy.com/uk/shop/MillionMilesCards



OUR PICK OF the month

"It's hard to choose which birds to craft from this adorable new crochet book by Kerry Lord – you get more than 40 designs in four different sizes!"

Rosee, Editor

Edwards Menagerie - birds, \$15.99 published by www.fwcommunity.com



BLOG WE www.purlbee.com

This is NYC craft store Purl Soho's blog, but it is not your average shop blog announcing new stock and sales. Instead it is a goldmine of creative ideas and step-by-step tutorials covering knitting, sewing, embroidering and weaving – plus a whole lot more besides. And of course there is no harm in clicking on the shop tab and browsing the spectacular selection of designer yarns, all beautifully shot and oh-so appealing, is there? Just for a look. Or maybe to buy a ball or two... Or four...



To celebrate the safe arrival of Princess Charlotte. Millamia are offering this Milly tanktop pattern as a free download, sized from 3 months to 5 years. Visit millamia.com



LET THEM KNIT CAKE

Are you crazy for cake or barmy over buns? The North York Moors is laying claim to the title of Britain's Capital of Cake in recognition of the myriad of different types of cake served in the area. Local business owners Christine Bentley of Castle Stores wool shop and Anna Lupton of Carr House Farm B&B are organizing the World Knitted cake festival in the wool shop to celebrate, and raise funds for their local hospital at Malton. Enter a knitted cake for £3 for a chance to win an afternoon tea at Ampleforth Abbey Tea Room, an expert knit tutorial with Maud and Christine and a night at Carr House Farm. The closing date for entries is 1st September 2015. For more details visit www.worldkfc.co.uk



A SUMMER OF Kaffe!

Kaffe Fassett has been designing textiles for more than 50 years. Since 1981 he's worked closely with Rowan to bring his designs into the hands of millions of knitters. His 50 year anniversary brings his spectacular colours to the forefront again. 2015 is the summer of colour and the summer of Kaffe! www.knitrowan.com

* Five minutes with...

LOUISA HARDING

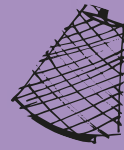

Louisa's modern designs have made her a familiar name with knitters around the world



How did you become a knitwear designer?

I studied Textiles for Fashion with Business Studies at what was Brighton Poly – now Brighton University.

Do you think you have a signature style in your designs?

I am unapologetically feminine in my

choice of yarns and therefore the designs I create. I design for the women in my life – they have all been and continue to be a huge inspiration.

Do you have a favourite yarn or material? Which is it and why do you like it?

I like anything with silk in it. Silk takes colour beautifully and has a beautiful shine and drape when knitted.

Where do you get your inspiration and ideas for your knitwear designs?

Inspiration is the most important factor when I am putting a collection of yarns and designs together. Inspiration can arrive in a variety of ways from reading a book, watching a movie to visiting a beautiful city or walking in the hills.

What's the thing you love most about being a knitwear designer?

Getting feedback from knitters. I can get stuck sometimes looking for inspiration, creatively thinking – what is this all for? Then I'll get an email from a knitter who has used one of my yarns or knitted one of my designs and really enjoyed the experience and they take the time to contact me to say thank you.

What are your favourite projects to design?

The next one! I'm lucky I get to play with yarn and design every day (even when on holiday – much to my husband's frustration) and there is always one more idea to try...

See more from Louisa Harding by visiting Designer Yarns, www.designeryarns.uk.com



IN STYLE



Rowan Nautical Cardigan, free download from www.knitrowan.com

Paris 100% Cotton from Drops, **£1.80 per 50g**



Nautical Cosmetics Bag from Marks&Spencer, **£5**



Chunky Nautical Rope Necklace from Accessorize, **£12**

You can download this gorgeous nautical cardigan for free!

in STYLE

This season knots of the sailing kind are the order of the day as jaunty nauticals hit the fashion high seas

Whether you're dreaming of owning a yacht, or climbing the rigging, this month's timeless fashion gathering will keep you looking ship shape. From cool cotton knits to coordinating nails, there's something to cater for everyone's love of things yo-ho-ho! 



Stripe Cardigan from Land's End, **£49.95**

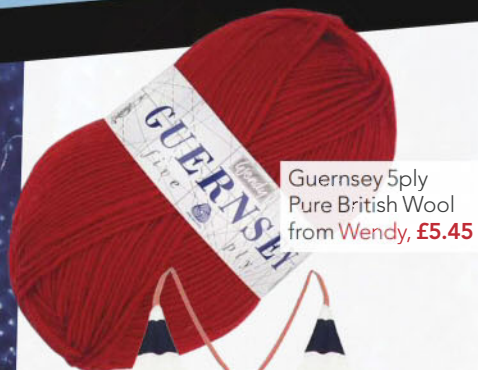

Guernsey 5ply Pure British Wool from Wendy, **£5.45**



Nautical Stripy Maxi Dress from Accessorize, **£32**

Principles Ben de Lisi Scarf from Debenhams, **£16**



Gold Crystal Fish Earrings from What's About Town, **£14.95**

Nail varnish from New Look, **£2.99 each**



Blazer from Wendy Cotton Collection Book 350 www.tbramsden.co.uk, **£9**



Retro Wayfarer Sunglasses from What's About Town, **£9.95**

Purplelinda Crafts

love to Crochet

— Crochet Cute Little Tatty Teddy —
with DMC Natura



16 New shades of Natura Just Cotton in YUMMY colours



KIT ONLY
£19.99

Visit us online for the largest selection of crochet supplies in the UK
www.purplelindacrafts.co.uk

Get Knitted

...for all your knitting & crochet needs



Stockist of
Rowan, King Cole,
Sidar, Rico,
Stylecraft,
KnitPro & Clover

Yarns, books,
patterns,
needles, hooks
& more

In-store
loyalty scheme

Open Monday-Friday 9.30-5.00
Saturday 10.00-5.00
30 Brislington Hill, Bristol BS4 5BE
0117 300 5211 www.getknitted.com



WOOL WAREHOUSE

Get **10% OFF EVERYTHING!**
Discount code: **KT114**



We're proud stockists of all these leading brands!

All the **knitting & crochet** supplies you'll ever need...
...all under one roof!

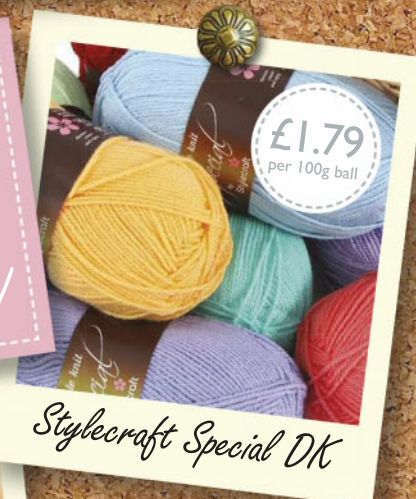

www.woolwarehouse.co.uk

FREE UK DELIVERY
on orders over £25

Order online: www.woolwarehouse.co.uk
Order over the telephone: 01926 882818 or 0800 505 3300
Email us: yarn@woolwarehouse.co.uk
No minimum order. £2.95 delivery charge for UK orders under £25.
* Discount code not valid on yarn packs or sale items.

For knitters just like you

knit

today

FREE ONE MONTH TRIAL
to the digital edition



Packed with fashionable knits for all the family plus great gift ideas for friends, *Knit Today* has something for everyone, whether you're new to knitting or are a seasoned pro. ***It's a knitter's must-buy*** for style, technical advice and inspiration.



Have *Knit Today* magazine delivered straight to your device when you take out a **one month free trial***

knit
today

Simply return to the homepage to subscribe

*After your one month trial your subscription will continue at £2.99 per month



RICO BABY SO SOFT DK – THE NEW COLOURS – *Adorable!*



VISIT OUR WEBSITE WWW.RICO-DESIGN.CO.UK

WorldMag.net



ANGELA TURNER

"I've made a few of these for friends' babies and put squeakers inside. They've always gone down really well with the under threes"

SKILL LEVEL



EASY

TECHNIQUES

- ◆ TOY MAKING
- ◆ INCREASING & DECREASING



EXCLUSIVE
KNIT TODAY PATTERN

Prehistoric pals

Brighten up any nursery with these super-friendly knitted dinosaur toys.

By *Angela Turner*

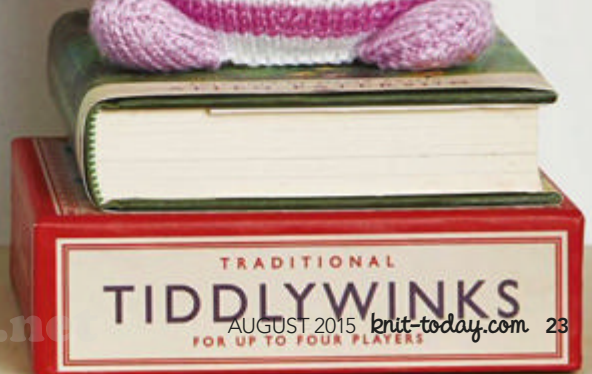



“They say dinosaurs evolved from birds, and I love that there is a hint of the chicken in these cuties!”



CHARLENE,
ART
EDITOR

From the Stegosaurus

with his ridged spine to the horned and armour plated skull of the Triceratops and the helmeted lizard that was Corythosaurus, the dinosaurs could be fearsome beasts – even these three herbivores! You won't see a snarl from these cute characters. They have some of the physical characteristics of the dinosaurs they are modelled on, but none of the nastiness. Instead they are just perfect for little ones of all ages to cuddle!

Materials

◆ Yarn
1 x 100g ball of Stylecraft Special DK in White (1001), plus 1 x 100g ball of Stylecraft Special DK in the following colours:

Stegosaurus

Sherbet (1034)
Cloud Blue (1019)

Turquoise (1068)

Corythosaurus

Spring Green (1316)
Meadow (1065)
Green (1116)

Triceratops

Clematis (1390)
Raspberry (1023)
Plus Stylecraft Life DK in
Clover (2358)

◆ Needles

1 pair of 3mm (UK 11)

◆ Accessories

Polyester filling

3 x 9.5cm or 3¾in diameter
circles of card

6 x black buttons for eyes

Yarn detail

◆ Stylecraft Special DK
www.stylecraft-yarns.co.uk

◆ 100% acrylic

◆ Double knit weight

◆ 100g/295m (322yds)

◆ Machine wash at 40°C

◆ £1.99

◆ Stylecraft Life DK

www.stylecraft-yarns.co.uk

◆ 25% wool, 75% acrylic

◆ Double knit weight

◆ 100g/298m (325yds)

◆ Machine wash at 40°C

◆ £2.99

Tension

26 sts and 34 rows over
10cm or 4in square in st st
using 3mm needles

Finished size

Each dinosaur measures
about 22cm or 8¾in tall

◆ Turn to page 92 for full
list of abbreviations

STEGOSAURUS

BODY

Begin at base using White and cast on 12 sts.

Row 1: Purl.

Row 2: Inc in every st. 24 sts

Row 3: Purl.

Row 4: (K1, inc in next st) to end. 36 sts

Row 5: Purl.

Row 6: (K2, inc in next st) to end. 48 sts

Row 7: Purl.

Row 8: (K3, inc in next st) to end. 60 sts

Row 9: Purl.

Row 10: Knit.

Row 11: Purl.

Row 12: (K4, inc in next st) to end. 72 sts

Row 13: Purl.

Row 14: Purl.

Starting with a purl row, work 3 rows st st.

Change to Sherbet and st st 2 rows.

Next row: (K5, inc in next st) to end. 84 sts

Next row: Purl.

Change to White and st st 4 rows.

Change to Sherbet and st st 4 rows.

Keeping stripe patt, work 24 more rows.

Change to White.

Next row: (K5, k2tog) to end. 72 sts

Starting with a purl row, work 13 rows st st.

Next row: (K4, k2tog) to end. 60 sts

Starting with a purl row, work 9 rows st st.

Next row: (K3, k2tog) to end. 48 sts

Starting with a purl row, work 5 rows st st.

Next row: (K2, k2tog) to end. 36 sts

Starting with a purl row, work 3 rows st st.

Next row: (K1, k2tog) to end. 24 sts

Next row: Purl.

Next row: (K2tog) to end. 12 sts

Next row: (P2tog) to end. 6 sts

Cut yarn and thread through.

Pull up tightly and sew seam for about 7cm or 2¾in.

Gather round cast on sts and pull up tightly.

Sew seam to last Sherbet stripe.

Turn right side out and insert the 9.5cm or 3¾in diameter circle of card then stuff with filling, a little at a time.

Sew up gap.

NOSE

Using Turquoise, cast on 6 sts and purl one row.

Next row: Inc in every st. 12 sts

Next row: Purl.

Rep last 2 rows again. 24 sts

Next row: (K1, inc in next st) to end. 36 sts

Next row: Purl.

Next row: Knit.

Next row: Purl.

Next row: (K2, inc in next st) to end. 48 sts

Next row: Purl.

Cast off. Gather round cast on sts and pull up tightly. Sew seam to cast off edge.



The dinosaurs' smiles are added to the knitting using daisy stitches



This Triceratops has an armoured frill made from garter stitch, not bone



Corythosaurus shows off his duck-billed beak and helmeted head

Gather round cast off sts and pull up gently. Add filling. Place on face so that bottom of nose touches bottom of last Sherbet stripe on body. Sew to face shaping slightly as you go to make an oval shape. Add more filling as needed. Using White, work a curved line of daisy sts starting half way down nose.

LEGS AND ARMS (MAKE 4)

Using Cloud Blue, cast on 10 sts and st st 8 rows.

Next row: K2tog, k last 2 sts, k2tog. 8 sts

Next row: Purl.

Next row: K2tog, k to last 2 sts, k2tog. 6 sts

Next row: Purl.

Next row: K2tog, k to last 2 sts, k2tog. 4 sts

Next row: Purl.

Next row: Inc in first st, k to last st, inc. 6 sts

Next row: Purl.

Next row: Inc in first st, k to last st, inc. 8 sts

Next row: Purl.

Next row: Inc in first st, knit to last st, inc. 10 sts

Starting with a purl row, st st 7 rows.

Cast off.

Fold paws in half and sew around edge leaving a gap. Turn right side out and stuff with filling lightly. Sew rem seam. Pin arms in place either side of body, aligned with the top Cloud Blue stripe. Sew in place securely. Pin feet to garter st row of base, with about 5cm or 2in between them.

TAIL

Using Sherbet, cast on 20 sts. St st 14 rows.

Next row: K2tog, k7, inc in next 2 sts, k7, k2tog.

Starting with a purl row, st st 3 rows.

Next row: K2tog, k7, inc in next 2 sts, k7, k2tog.

Next row: Purl.

Next row: K2tog, knit to last 2 sts, k2tog. 18 sts

Next row: Purl.

Next row: K2tog, k6, inc in next 2 sts, k6, k2tog.

Next row: P2tog, purl to last 2 sts, p2tog. 16 sts

Next row: K2tog, k5, inc in next 2 sts, k5, k2tog.

Next row: P2tog, purl to last 2 sts, p2tog. 14 sts

Next row: K2tog, knit to last 2 sts, k2tog. 12 sts

Next row: P2tog, purl to last 2 sts, p2tog. 10 sts

Rep last 2 rows again. 6 sts

Next row: K2tog to end. 3 sts

Cut yarn and thread through.

Fold in half and sew seam. Turn right side out and stuff gently with filling. Place at rear of dinosaur starting at the garter stitch row and sew to dinosaur securely.

MEDIUM SHIELDS (MAKE 2)

Using Turquoise, cast on 10 sts and st st 6 rows.

Next row: K2tog, knit to last 2 sts, k2tog. 8 sts

Next row: Purl.

Next row: K2tog, knit to last 2 sts, k2tog. 6 sts

Next row: Purl.

Next row: K2tog, knit to last 2 sts, k2tog. 4 sts



A circular card insert at the base provides stability and structure

Next row: Purl.

Next row: Inc in first st, knit to last st, inc. 6 sts

Next row: Purl.

Next row: Inc in first st, knit to last st, inc. 8 sts

Next row: Purl.

Next row: Inc in first st, knit to last st, inc. 10 sts

Starting with a purl row, st st 5 rows.
Cast off.

SMALL SHIELDS (MAKE 4)

Using Turquoise, cast on 6 sts and st st 4 rows.

Next row: K2tog, knit to last 2 sts, k2tog. 4 sts

Next row: Purl.

Next row: K2tog twice. 2 sts

Next row: Purl.

Next row: Inc in each st. 4 sts

Next row: Purl.

Next row: Inc in each st. 6 sts

Starting with a purl row, st st 3 rows.
Cast off.

LARGE SHIELDS (MAKE 3)

Using Turquoise, cast on 12 sts and st st 8 rows.

Next row: K2tog, k to last 2 sts, k2tog. 10 sts

Next row: Purl.

Next row: K2tog, k to last 2 sts, k2tog. 8 sts

Next row: Purl.

Next row: K2tog, k to last 2 sts, k2tog. 6 sts

Next row: Purl.

Next row: K2tog, k to last 2 sts, k2tog. 4 sts

Next row: Purl.

Next row: Inc in first st, k to last st, inc. 6 sts

Next row: Purl.

Next row: Inc in first st, k to last st, inc. 8 sts

Next row: Purl.

Next row: Inc in first st, k to last st, inc. 10 sts

Next row: Purl.

Next row: Inc in first st, knit to last st, inc. 12 sts

Starting with a purl row, st st 7 rows.

Cast off.

Fold all shields in half and sew seam.

Turn right side out and sew across cast on and cast off sts. Place at centre of head,

starting about 8 rows down from top of head at front, working upwards in the following order, with shields facing each other but overlapping slightly:

4 small shields, 2 medium shields then 3 large shields.

Ensure all loose ends are tied in securely to finish.

TRICERATOPS

Using White and Clover, work body and tail as for Stegosaurus. Use Clematis to make the arms and legs and Raspberry to make the nose. Sew together as for Stegosaurus.

NECK PLATE

Using 2 strands of Raspberry, cast on 6 sts.

First row: Inc in first st, knit to last 2 sts, turn. 7 sts

Next row: Knit.

Next row: Inc in first st, knit to end. 8 sts

Next row: Knit.

Next row: Cast off 2 sts, knit to end. 6 sts

Next row: Knit.

Rep last 6 rows 7 times more.

Cast off.

Place neck plate on back of head, starting in line with the eyes, going over the head then down to second eye. Check it is even then sew in position securely.

HORNS (MAKE 3)

Using Clover, cast on 10 sts and purl one row.

Next row: (K2tog, k2) to last 2 sts, k2tog. 7 sts

Starting with a purl row, st st 3 rows.

Next row: K2tog, k3tog, k2tog. 3 sts

Next row: Purl.

Next row: K3tog.

Fasten off.

Sew seam then turn right side out. Stuff with filling. Sew one horn on top of nose then other 2 at front of head, about 3cm or 1¼in down from top centre head, with about 2.5cm or 1in between them. Ensure all loose ends are tied in securely to finish.

CORYTHOSAURUS

Using White and Spring Green, work body and tail as for Stegosaurus. Use Meadow to make the arms and legs and Green to make the nose. Sew together as for Stegosaurus.

HEAD SHIELD

Using Green, cast on 22 sts and work 7 rows st st.

Next row: Knit.

Next row: Knit.

Next row: Purl.

Next row: Purl.

Starting with a purl row, st st 6 rows.

Cast off purlways.

Fold in half lengthways and sew end seams together. Turn right side out and sew across seam. Place seam on centre of head starting about 7 rows down from top at front and working back. Sew in place securely. 



Let's be knitting buddies

..... and together we will be in good company

Tel: 0845 003 0775
Email: enquiries@wool4less.co.uk
Chat online for instant support

FREE PATTERNS
FREE EXCHANGES
DISCOUNTED PACKS

10% OFF
your next order
Use coupon code
KBKT15

With a LARGE selection of yarns & patterns combined with MASSIVE savings why not visit us at

www.wool4less.co.uk

McAree Brothers

all enquiries 0131 558 1747

Shop on-line @ www.mcadirect.com

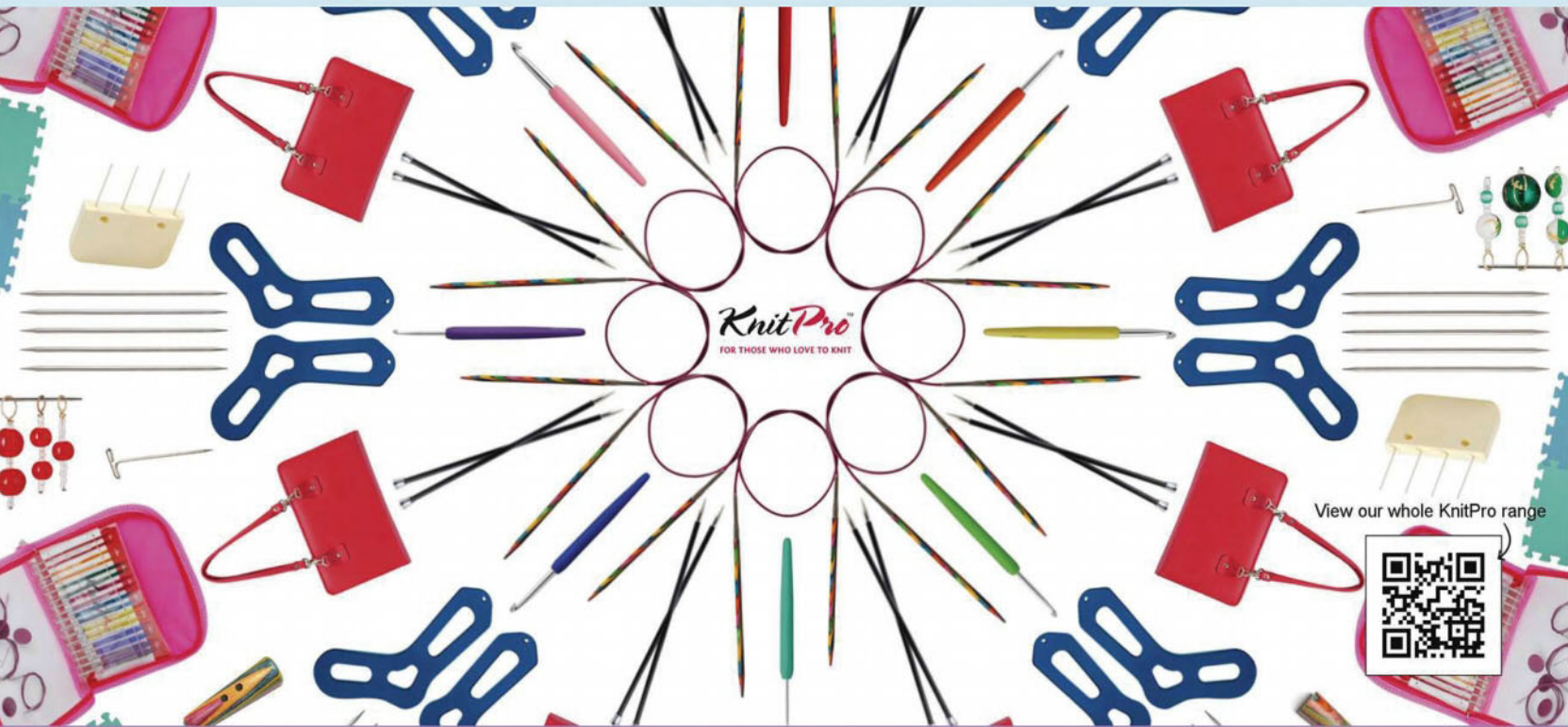

KnitPro
FOR THOSE WHO LOVE TO KNIT

View our whole KnitPro range



Edinburgh 19 Howe Street WorldMags.net 55-59 King Street Stirling

5 ISSUES FOR £5

when you subscribe today*

Have you seen our full range of knit magazines? Don't miss out, subscribe today!



Simply Knitting is the UK's best-selling knitting magazine. You'll find lots of exciting patterns in every issue, plus real-life reader stories, knitting news and great products too.



The Knitter is packed full of world class designs and inspiring ideas from top designers. Ideal for skilled knitters with more than 10 patterns in each issue.

GREAT REASONS TO SUBSCRIBE

- ✓ Get **5 issues for just £5***
- ✓ After this, save up to **30% on the shop price**
- ✓ **Free UK delivery** direct to your door - never miss an issue!

**SAVE
80%**

SUBSCRIBE AND SAVE TODAY

CALL NOW on
0844 844 0388
and quote code X1323

Order online at
www.buysubscriptions.com/knitp
and enter code X1323

*5 issues for £5 is available to UK Direct Debit orders only. After your first 5 issues, your subscription will continue at just £24.49 every 6 issues thereafter for *Simply Knitting* - saving 24%. For *The Knitter*, after your first 5 issues your subscription will continue at just £29.59 every 6 months thereafter - saving 24%. If you cancel within 2 weeks after receiving your fourth issue, you will pay no more than £5. Offer ends 30th September 2015.

SKILL LEVEL



EASY

TECHNIQUES

- ◆ LACE DETAIL
- ◆ SHAPING

KNIT TODAY
WOMEN'S GARMENT

Denim-blue delight

Make life easy with this great make that'll
match everything in your wardrobe
by **Grace Melville**



"The beautifully delicate lace detail on the sleeves really sets this knitted top apart from the crowd"



SOPHIE, OPERATIONS EDITOR

Worn every day or glammed up for a special night out, this versatile denim look t shirt makes the best of both worlds. Worked in Rowan's Original Denim 100% cotton range you'll enjoy knitting it all year round!

Materials

- ◆ Yarn
10 (11:12:13:15) x 50g balls of Rowan Original Denim in Nashville (shade 002)
- ◆ Needles
1 pair 3.25mm (UK 10, US 4)
- 1 pair 4mm (UK 8, US 6) needles

Yarn detail

- ◆ Rowan Original Denim

yarn www.knitrowan.com.
01484 681881

- ◆ 100% cotton
- ◆ 50g/100m (109 yards)
- ◆ Machine wash at 60°C
- ◆ £3.95

Tension

Before washing: 20 sts and 28 rows to 10cm or 4in measured over st st using 4mm needles. 20 sts and 30 rows to 10cm or 4in measured over lace patt using 4mm needles.

After washing: 20 sts and 32 rows to 10cm or 4in measured over st st using 4mm needles. 20 sts and 36 rows to 10 cm measured over lace patt using 4mm needles.

Tension note: Denim will shrink in length when washed for the first time. Work to lengths give in pattern (see size diagram for 'after washing' measurements).

- ◆ Turn to page 92 for full list of abbreviations



Pattern from Rowan Knitting & Crochet Magazine 57, £12.50 www.knitrowan.com

BACK

Using 3.25mm needles **cast on** 112 (122:134:146:160) sts.
Knit 6 rows, ending with RS facing for next row.
Change to 4mm needles.
Beg with a K row, work in st st until back measures 60.5 (63:65:67.5:69.5) cm, **24** (24¾:25½:26½:27¼) in, ending with RS facing for next row.

SHAPE SHOULDERS

Cast off 5 (5:6:7:8) sts at beg of next 2 rows. 102 (112:122:132:144) sts

SHAPE BACK NECK

Next row (RS): Cast off 5 (6:6:7:8) sts, knit until there are 26 (30:34:38:42) sts on right needle and turn, leaving rem sts on a holder. Work each side of neck separately.
Dec 1 st at the neck edge of the next 6 rows and at same time cast off 5 (6:7:8:9) sts at beg of 2nd and foll 2 alt rows.
Work 1 row.
Cast off rem 5 (6:7:8:9) sts.
With RS facing, slip centre 40 (40:42:42:44) sts onto a holder (for neckband), rejoin yarn and knit to end.
Complete to match first side, reversing neck shapings.

FRONT

Work as given for back until 10 (10:12:12:14) rows fewer have been worked than on back to beg of shoulder shaping, ending with RS facing for next row.

SHAPE FRONT NECK

Next row (RS): K39 (44:50:56:63) and turn, leaving rem sts on a holder.
Work each side of neck separately.
Dec 1 st at neck edge of next 6 rows, then on foll 1 (1:2:2:3) alt rows.
32 (37:42:48:54) sts
Work 1 row, ending with RS facing for next row.

SHAPE SHOULDER

Cast off 5 (5:6:7:8) sts at beg of next and foll 4 (0:1:1:1) alt rows, then 0 (6:7:8:9) sts at beg of foll 0 (4:3:3:3) alt rows and at same time dec 1 st at neck edge of next and foll 4th row.
Work 1 row.
Cast off rem 5 (6:7:8:9) sts.
With RS facing, slip centre 34 sts onto a holder (for neckband), rejoin yarn and k to the end.
Complete to match first side, reversing the shapings.

SIZING GUIDE		8-10	12-14	16-18	20-22	24-26
TO FIT BUST	cm	81-86	91-97	102-107	112-117	122-127
	in	32-34	36-38	40-42	44-46	48-50
ACTUAL BUST	cm	56	61	67	73	80
	in	22	24	26½	28½	31½
LENGTH TO BACK NECK	cm	56	58	60	62	64
	in	22	23	23½	24½	25
SLEEVE LENGTH	cm	6.5	6.5	6.5	6.5	6.5
	in	2½	2½	2½	2½	2½



This unique yarn also comes in a lighter shade – Memphis (001)



The lovely lacy detail on this top's sleeves adds that extra special touch



Garter stitch is worked at the bottom of the top to give it a definitive edge

SLEEVES

Using 3.25mm needles cast on 63 (67:71:75:79) sts.

Work in g st for 6 rows, ending with RS facing for next row.

Change to 4mm needles.

Now work in lace patt as folls:

Row 1 (RS): K1 (1:3:5:7), (k2tog, yfwd) 0 (1:1:1:1) times, *k1, yfwd, sl1, k1, pssso, k5, k2tog, yfwd, rep from * to last 2 (4:6:8:10) sts, (k1, yfwd, sl1, k1, pssso) 0 (1:1:1:1) times, k2 (1:3:5:7).

Row 2 and every foll alt row (RS): Purl.

Row 3: K1 (0:2:4:1), (yfwd, sl1, k1, pssso, k3) 0 (0:0:0:1) times, (k2tog, yfwd, k1) 0 (1:1:1:1) times, *k2, yfwd, sl1, k1, pssso, k3, k2tog, yfwd, k1, rep from * to last 2 (4:6:8:10) sts, (k2, yfwd, sl1, k1, pssso) 0 (1:1:1:0) times, k2 (0:2:4:0).

Row 5: Inc in first st, k0 (2:0:2:1), (yfwd, sl1, k1, pssso, k1) 0 (0:0:0:1) times, (k2tog,

yfwd, k2) 0 (0:1:1:1) times, *k3, yfwd, sl1, k1, pssso, k1, k2tog, yfwd, k2, rep from * to last 2 (4:6:8:10) sts, (k3, yfwd, sl1, k1, pssso) 0 (0:1:1:1) times, (k1, k2tog, yfwd) 0 (0:0:0:1) times, k1 (3:0:2:1), inc in last st.

65 (69:73:77:81) sts

Row 7: K2 (4:1:2:0), (k2tog, yfwd, k3) 0 (0:1:0:0) times, (yfwd, sl1, k2tog, pssso, yfwd, k3) 0 (0:0:1:0) times, *k4, yfwd, sl1, k2tog, pssso, yfwd, k3, rep from * to last 3 (5:7:9:1) sts, (k4, yfwd, sl1, k1, pssso) 0 (0:1:0:0) times, (k4, yfwd, sl1, k2tog, pssso, yfwd) 0 (0:0:1:0) times, k3 (5:1:2:1).

Row 9: K0 (2:1:1:0), (k2tog, yfwd) 1 (1:0:1:0) times, *k1, yfwd, sl1, k1, pssso, k2tog, yfwd, rep from * to last 3 (5:2:4:1) sts, (k1, yfwd, sl1, k1, pssso) 1 (1:0:1:0) times, k0 (2:2:1:1).

Row 11: As row 9.

Row 13: As row 9.

Row 15: Inc in first st, k1 (1:0:0:0), (yfwd, sl1, k1, pssso) 0 (0:0:0:1) times, (k2tog, yfwd)

0 (1:0:1:1) times, *k1, yfwd, sl1, k1, pssso, k2tog, yfwd, rep from * to last 3 (5:2:4:1) sts, (k1, yfwd, sl1, k1, pssso) 0 (1:0:1:0) times, k2 (1:1:0:0), inc in last st. 67 (71:75:79:83) sts

Row 17: K1 (0:0:2:1), (k2tog, yfwd) 1 (0:1:1:0) times, *k1, yfwd, sl1, k1, pssso, k2tog, yfwd, rep from * to last 4 (1:3:5:2) sts, (k1, yfwd, sl1, k1, pssso) 1 (0:1:1:0) times, k1 (1:0:2:2).

Row 19: K0 (2:4:1:1), (yfwd, sl1, k1, pssso, k3) 0 (0:0:1:0) times, (k2tog, yfwd, k1) 1 (1:1:1:0) times, *k2, yfwd, sl1, k1, pssso, k3, k2tog, yfwd, k1, rep from * to last 4 (6:8:0:2) sts, (k2, yfwd, sl1, k1, pssso) 1 (1:1:0:0) times, k0 (2:4:0:2).

Row 21: K3 (1:3:2:1), (yfwd, sl1, k1, pssso, k1) 0 (0:0:1:0) times, (k2tog, yfwd, k2) 0 (1:1:1:0) times, *k3, yfwd, sl1, k1, pssso, k1, k2tog, yfwd, k2, rep from * to last 4 (6:8:0:2) sts, (k3, yfwd, sl1, k1, pssso) 0 (1:1:0:0) times, k4 (1:3:0:2).

Row 23: K3 (0:1:3:1), (k2tog, yfwd, k3) 0

DENIM-LOOK T-SHIRT

(1:0:0) times, (yfwd, sl1, k2tog, pss0, yfwd, k3) 0 (0:1:1:0) times, *k4, yfwd, sl1, k2tog, pss0, yfwd, k3, rep from * to last 4 (6:8:0:2) sts, (k4, yfwd, sl1, k1, pss0) 0 (1:0:0:0) times, (k4, yfwd, sl1, k2tog, pss0, yfwd) 0 (0:1:0:0) times, k4 (0:1:0:2).

Row 24: Purl.

Cast off.

MAKING UP

Do NOT press. Join right shoulder seam using back stitch, or mattress stitch if preferred.

Neckband

With RS facing and using 3.25mm needles, pick up and knit 15 (15:17:17:19) sts down left side of front neck, k across 34 sts on front holder, pick up and knit 15 (15:17:17:19) sts up right side of front neck, and 7 sts down right side of back neck, k across 40 (40:42:42:44) sts on back holder, then pick up and knit 7 sts up left side of back neck. 118 (118:124:124:130) sts. Knit 6 rows, ending with WS facing for next row. Cast off knitwise (on WS). Machine wash all pieces and lay flat to dry before completing sewing together. Mark points along side seam edges 18 (19:20:21:22) cm, 7 (7½:8:8¼:8½) in, either side of shoulder seams (to denote base of armholes). Mark points along side seam edges 18 (19:20:21:22) cm, 7 (7½:8:8¼:8½) in, the either side of shoulder seams (to denote base of armholes). Sew top edge of sleeve between these points with a small back stitch or mattress stitch. With wrong sides together join side and sleeve seams with a small back stitch or mattress stitch. 

BLOCKING DIAGRAM

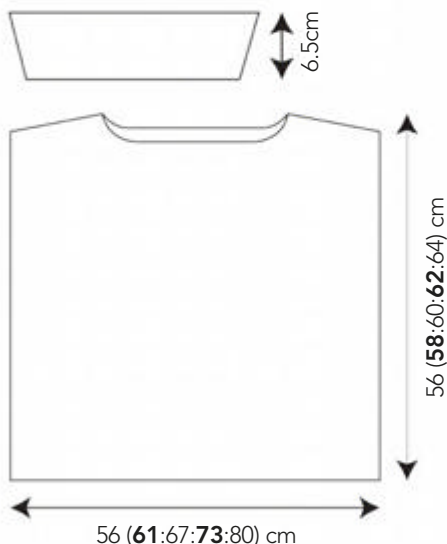

Enjoy this straightforward knit you'll wear over and over again!



King
Cole

Knitted Toy Collection

Available Toy Patterns

For your local stockist call: 01756 703670 or email: enquiries@kingcole.co.uk

www.kingcole.com



**JACQUI
HARDING**

"Bamboo yarn, simple lace and no-wrap short rows make this headband a fun, make for breezy summer days."

SKILL LEVEL



INTERMEDIATE

TECHNIQUES

- ◆ LACE PATTERN
- ◆ SHORT ROWS



EXCLUSIVE
KNIT TODAY PATTERN

Heading out!

Turn heads this summer with a lacy headband in deep plum

By **Jacqui
Harding**

Pattern
info

“Quick to knit, this quirky headband makes a great gift for friends”



CHARLENE,
ART
EDITOR

This wonderfully easy to wear headband is created using a simple lace pattern, and looks stunning for the warm summer months. Simple short rows (no wrapping!) shape the band to minimise bulk at the back and an elastic hairband closure makes for a perfect, no hassle fit.

Materials

- ◆ Yarn
1 ball of King Cole Bamboo Cotton in Plum (shade 1017)
- ◆ Needles
3.5mm needles (UK 10/9, US 4)
- ◆ Accessories
1 hair elastic in matching colour

Yarn detail

- ◆ King Cole Bamboo Cotton

www.kingcole.co.uk
01756 703670

- ◆ 4ply
- ◆ 48% bamboo viscose, 52% cotton
- ◆ 100g/371m (405 yards)
- ◆ Machine wash at 30°C
- ◆ £6.19

Tension

23 sts and 36 rows in stocking stitch to 10cm or 4in using 3.5mm needles. 1 lace pattern repeat measures 3cm or 1¼in across when blocked.

Finished size

To fit head measuring 51cm to 59cm or 20in to 23in.

Pattern notes

The centre stitches are worked in lace pattern throughout, with stocking stitch on either side. The stocking stitch panels are worked as short rows, so the rows get progressively shorter to the half way point, then longer again until all the stitches are being worked once more.

Special abbreviations

PM	place marker
slm	slip marker
sk2p	slip 1, knit 2 together, pass slipped stitch over

- ◆ Turn to page 92 for full list of abbreviations

LITTLE ARROWHEAD LACE PATTERN

Row 1 (RS): K1, *yo, ssk, k1, k2tog, yo, k1; rep from *

Row 2 (WS): P.

Row 3: K2, *yo, sk2p, yo, k3; rep from * to last 5 sts, yo, sk2p, yo, k2.

Row 4: P.

HEADBAND

Cast on 91 sts.

Work in 1 x 1 rib for 4 rows.

Row 1 (RS): K24, PM, work row 1 of lace pattern to last 24 sts (7 lace reps), PM, k24.

Row 2 (WS): P.

Row 3: K24, slm, work row 3 of lace pattern to marker, slm, k24.

Row 4: P to last 3 sts, turn.

Row 5 (short row): K to marker, slm, work in pattern to marker, slm, k to last 3 sts, turn.

Row 6 (short row): P to 2 sts before end of short row, turn.

Row 7 (short row): K to marker, slm, work in pattern to marker, slm, k to 2 sts before end of short row, turn.

Rep rows 6 and 7 until you have 3 sts on either side of the lace panel.

Increase rows

Next row (WS): P to 2 sts past short row, turn.

Next row (RS): K to marker, slm, work in pattern to marker, slm, k to 2 sts past short row, turn.

Rep last two rows until you have 3 sts left on either side.

Work row 1 again, but p to 3 sts past short row (ie to end), turn.

Work row 2 again, but knit to end.

Work in established pattern for 2 more rows (should end with lace pattern row 4), then work one more row in pattern.

Switch to k1, p1 rib for 4 rows, bind off, leaving a long tail.

Blocking and making up

Soak and lay headband out to dry, pinning the lace pattern into a rectangle. When dry, sew the elastic hair band to the short edge using whip stitch. If the band has stretched you can shorten it by wrapping the edge of the headband around the elastic before sewing in place. Repeat on the other side.

FITTING NOTES

Make a narrower band by working the short rows every 3 or 4 stitches rather than every 2. Work until the band is half the width you want, then work back across the short rows in the same way as described. Make the headband 3cm shorter by removing a 6 st repeat from the lace panel. 

BLOCKING DIAGRAM

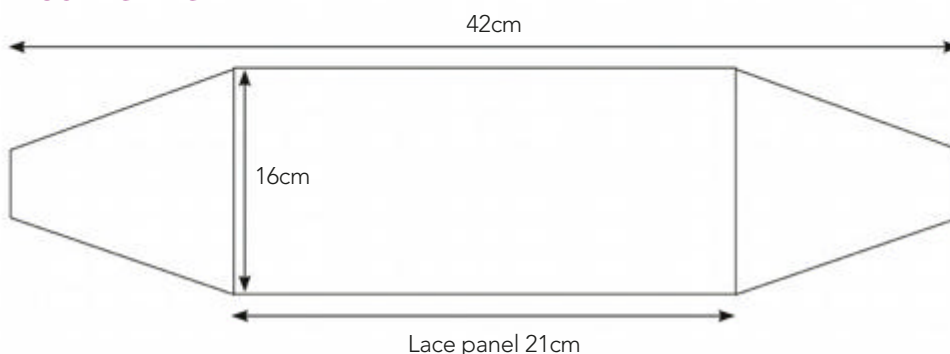

NEW ISSUE!



PREMATURE COLLECTION



TUMMY TIME BLANKET



PRETTY LACE CARDIGAN



OH SO COOL BEACHWEAR

Love Knitting

Beautiful baby knits magazine **FOR BABY**

Only **£4.99** including p&p



Don't miss it!

Our July issue is packed with gorgeous patterns that you'll love to knit, from baby beachwear to a delicate lace cardigan, plus a collection of specially designed premature garments.

At just £4.99 this issue includes:

- ✿ 28 beautiful patterns
- ✿ Premature baby collection
- ✿ New season yarn guide
- ✿ Three fab cuddly toys

ADORABLE CAT & BUNNY



ORDER YOUR COPY TODAY!

CALL 0844 844 0388 and quote 'Love Knitting July 15'
ONLINE www.buysubscriptions.com/loveknitting

Lines open weekdays 8am to 8pm and Saturday 9am to 1pm. [LdMags.net](http://www.LdMags.net)
Overseas please call +44 (0) 1795 414 676 EUR price £6.99, ROW price £7.99. All prices include p&p

SKILL LEVEL



EASY

TECHNIQUES

- ◆ SHAPING
- ◆ GRAFTING

part 2
CROPPED
TOP

KNIT TODAY
CHILDREN'S PATTERN

Garden games

Enjoy the second instalment of these
gorgeous knits for little girls
by *Bergère de France*



"Choose from a great selection of lovely, flecked Bigarelle shades."



CHARLENE, ART EDITOR

This gorgeous cropped top is designed to be worn with the vest top from the previous issue. Fashioned from just two balls of yarn, this cute combo is fabulously cost effective and wonderfully fun to make for your favourite little girl.

Materials

- ◆ Yarn
- A** 1 x 50g ball of Bergère Bigarelle in Beige (shade 297.211)
- B** 1 x 50g ball of Bergère Bigarelle in Roseaie (shade 346.031)

- ◆ Needles
- A pair of 2.5 mm (UK 12, US 2)
- A pair of 3 mm (UK 11, US 2/3)
- ◆ Accessories
- Stitch markers

Yarn detail

- ◆ Bergère de France Bigarelle www.bergeredefrance.co.uk
- ◆ 4 ply weight
- ◆ 9% viscose, 36% linen, 55% organic cotton
- ◆ 100g/390m (426 yds)
- ◆ Machine wash at 30°C
- ◆ £7.95

Tension

26 sts and 34 rows over st st using 3mm needles to 10cm or 4in square.

◆ Turn to page 92 for full list of abbreviations



These designs are taken from Bergère de France magazine 179. Visit www.bergeredefrance.co.uk

ARMHOLES

Cast off at the beg of every row as foll: 3 sts (**0:2:2:2:4**) times, then 2 sts (**4:2:2:4:2**) times. 65 (**70:77:81:88**) sts rem.
Next row (RS dec): K2, k2tog, work to last 4 sts, sl1, k1, psso, k2. 63 (**68:75:79:86**) sts
 Rep this dec on every foll RS row 2 (**2:3:2:3**) times more. Cont on the rem 59 (**64:69:75:80**) sts until work measures 18 (**21:24:27:30**) cm, 7 (**8¼:9½:10¾:12**) in, or 62 (**72:82:92:102**) rows in total. **

SHOULDERS & NECK

Cast off 4 (**5:5:6:6**) sts, work 12 (**12:13:14:15**) sts, cast off the central 27 (**30:33:35:38**) sts for the neck, work rem 16 (**17:18:20:21**) sts. Each side will now be completed separately.
Next row (WS): Cast off 4 (**5:5:6:6**) sts, work to central cast off sts and put rem sts on a stitch holder.
Next row (RS): Cast off 2 sts at neck edge, work to end.
Next row (WS): Cast off 5 (**5:5:6:6**) sts, work to end. Work 1 row straight.
Next row (WS): Cast off 5 (**5:6:6:7**) sts. With WS facing pick up sts left on the stitch holder.
 Cast off 2 sts, work to end.
Next row (RS): Cast off 5 (**5:5:6:6**) sts, work to end. Work 1 row straight.
Next row (RS): Cast off 5 (**5:6:6:7**) sts.

FRONT

Work as for Back to ** (after armhole shaping).
 Cont on the rem 59 (**64:69:75:80**) sts until work measures 14 (**17:19:22:25**) cm, 5½ (**6¾:7½:8¾:10**) in, or 48 (**58:66:76:86**) rows in total ending with a WS row.

ARMHOLES

Next row (RS): Work 22 (**23:25:27:28**) sts, cast off the central 15 (**18:19:21:24**) sts, work to end.
Next row (WS): Work to cast off sts and put rem sts on a stitch holder. Work will now be completed in two sections.
 Cont to cast off at the beg of every RS row (neck edge) as foll: 3 sts once, 2 sts once, 1 st 3 (**3:4:4:4**) times.
 Cont on the rem 14 (**15:16:18:19**) sts until work measures 18 (**21:24:27:30**) cm, 7 (**8¼:9½:10¾:12**) in, or 62 (**72:82:92:102**) rows in total.

NECK

Cast off at the beg of every WS row as foll: 4 (**5:5:6:6**) sts 1 (**3:2:3:2**) times, then 5 (**0:6:0:7**) sts 2 (**0:1:0:1**) times. With WS facing pick up sts for left front.

SIZING GUIDE		2 YEARS	4 YEARS	6 YEARS	8 YEARS	10 YEARS
FINISHED CHEST	cm	44	48	52	56	60
	in	17½	19	20½	22	23½
LENGTH TO BACK NECK	cm	17	20	23	26	29
	in	6½	8	9	10	11½

STITCHES USED

STOCKING STITCH (ST ST)
 Using 2.5 mm and 3mm needles.

Row 1 (RS): Knit

Row 2: Purl

Repeat these 2 rows.

STRIPE SEQUENCE A

Work 6 rows in B, 6 rows in A.

Rep these 12 rows.

STRIPE SEQUENCE B

Work 2 rows in B, 2 rows in A.

Rep these 4 rows.

BACK

Using 2.5mm needles and A cast on 73 (**80:87:95:104**) sts.

Starting with a knit row work in st st.

When work measures 2cm or ¾in, or 8 rows in total, change to 3mm needles and cont in st st until work measures 4cm or 1½in, or 14 rows in total ending with a WS row. Cont in st st working stripe sequence A until work measures 6 (**8:10:12:14**) cm (**2¼:3:4:4¾:5½**) in, or 22 (**28:36:42:48**) rows in total ending with a WS row.



Cont to cast off at the beg of every WS row (neck edge) as foll: 3 sts once, 2 sts once, 1 st 3 (3:4:4) times.

Cont on the rem 14 (15:16:18:19) sts until work measures 18 (21:24:27:30) cm, 7 (8¼:9½:10¾:12) in, or 62 (72:82:92:102) rows in total.

SHOULDER

Cast off at the beg of every RS row as foll: 4 (5:5:6:6) sts 1 (3:2:3:2) times, then 5 (0:6:0:7) sts 2 (0:1:0:1) times.

SLEEVES

Using 2.5mm needles and A cast on 46 (49:51:54:57) sts. Starting with a knit row work in st st. When work measures 2cm or ¾in, or 8 rows in total change to 3mm needles and cont in st st until work measures 2.5cm or 1in, or 10 rows in total. Cont in st st working stripe sequence B until work measures 5.5cm or 2¼in, or 20 rows in total.

Next row (RS inc): K2, inc1, work to last 2 sts, inc1, k2.

Rep this inc on every foll 14th (14th:12th:12th:12th) row 3 (4:4:7:8) times, then on every foll 0 (0:10th:0:0) row 0 (0:2:0:0) times.

Cont on the 54 (59:65:70:75) sts obtained until work measures 22 (26:29:33:37) cm, (8¾:10¼:11½:13:14½) in, or 76 (90:100:114:128) rows in total ending with a WS row.

TOP OF SLEEVE

Cast off at the beg of every row as foll: 0 (3:3:3:3) sts 0 (2:2:2:4) times, 2 sts 2 (2:2:4:2) times. 50 (49:55:56:59) sts rem.

Next row (RS dec): K2, k2tog, work to last 4 sts, sl1, k1, pssso, k2.

Rep this dec on every foll RS row 11 (10:11:10:12) times. 26 (27:31:34:33) sts rem.

Then cast off at the beg of every row as foll: 2 sts 4 (2:4:2:2) times, 0 (3:3:3:3) sts 0 (2:2:4:4) times, then the rem 18 (17:17:18:17) sts.

NECKBAND

Using 2.5mm needles and A cast on 85 (90:95:105:110) sts. Starting with a knit row work in st st until your work measures 2cm or ¾in, or 8 rows in total. Leave these stitches on a spare needle.

TO MAKE UP

Join shoulder seams. Graft the neckband around the neck edge of the top then sew the short ends of the neckband together using an invisible seam working on the RS.

Sew the top of each sleeve into the armholes. Sew the side and sleeve seams together, sewing the first 8 rows on the RS to allow for turn up. Let the neck, bottom of body and bottom of sleeve roll up slightly and stitch it in place using sewing needle and cotton. Secure and weave in all ends. *bt*

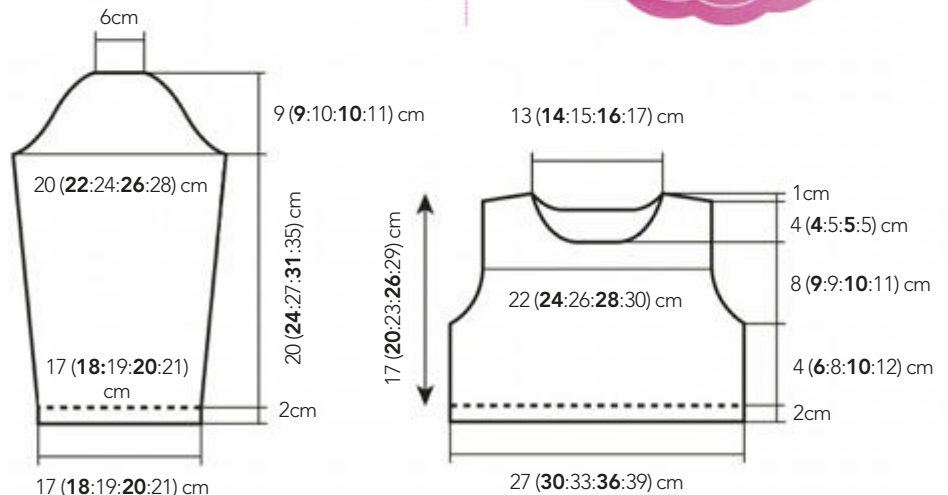

BLOCKING DIAGRAM



Embrace a handmade summer this year and fill their wardrobes with linen-mix knits in cool stripes

We'd love to hear from you
email knittoday@immediate.co.uk
write to: Knit Today, 2nd Floor, Tower House
Fairfax Street,
Bristol BS13BN

hi there

or drop us a line on  

Write in and show us what you've been working on. Every letter printed will win a prize!

KNITTING BONES

Busy lives often makes knitting a treat but with a fractured foot, and the need to slow down and rest, the knitting needles are knitting! An opportunity to make gifts for presents instead of buying them! A simple chunky, all-in-one jacket and a pair of cable socks. I have not used my cable needles for some time. The one I used is no longer straight! I bent it into a J. So much easier to use! Two enjoyable projects completed. Next...

Belinda Fielder, Abergavenny

Charlene says: I love the chunkiness of this jacket – it's going to keep a little person very snugly and warm! Glad to see you haven't been bored while resting up, Belinda. We hope you're making a speedy and complete recovery.



HAPPY HANDICRAFTS

I taught myself to knit and crochet about ten years ago now. I used books, websites and YouTube videos. I took it up

as I am disabled, and amongst other things have arthritis. So it was for a hobby as well as a way to keep my fingers and hands moving. I started with baby and dog items and progressed from there. Currently I am making baby items for the local hospital's SCBU (special care baby unit), blankets, hats, jumpers etc. I am also making nature-themed items for a local church which is planning on yarn bombing its railings outside. Knitting



Put an octopus on your head if you love knitted sea creatures!



provides a huge social aspect for me too – I go to a weekly group in a local library. I am always learning new techniques.

Janie Storer, Gateshead

Charlene says: These are amazing, Janie! Especially those eyelash yarn hedgehogs. Please send us a photograph of the yarn-bombed church when it's finished – I bet it's going to look amazing! Have any other *Knit Today* readers been yarn bombing lately?

Artesano



A KNITTED BLESSING

This baby blessing dress was something I knitted to keep for myself for when I have a baby girl but when I finished it, it was so cute I gave it to a friend who is due soon. I love the lacy details and since none of my friends are knitters, this will be the perfect baby shower gift for the future!

Vanessa Giovanna Bondy-Davenport, Toronto

Sophie says: This is a beautiful dress – we'd love to know what pattern you

used to create such a delicate lace design. Readers looking for a similar knit should try Christening Set in King Cole Comfort DK (3536) which costs £2.99 from www.deramores.com. How lovely to have a new baby arriving soon – you'll have lots of opportunity to knit for her as she grows up!

win
Lovely yarn and patterns from Artesano

Each month, our lucky star letter writer will win a gorgeous Artesano pattern and yarn, worth £30. For more information about Artesano and to find a stockist, visit www.artesanoyarns.co.uk For a chance of winning our Star Letter prize, write to the address above or email knittoday@immediate.co.uk



SHARING THE LOVE

As a fairly new knitter I find your magazine inspiring. I was lucky to have a very patient teacher (thanks, Sarah), and now belong to a supportive group (thanks to all the ladies at Miss Peapods Kitchen Cafe knitting

group). Knitting supports my mindfulness journey and I love having handmade items for myself, family and friends. Here is a photo of my scarf and hat, my bunting and some squares trying out new techniques to be sewn together as a cushion cover.

Jan Webb, Cornwall

Rosee says: You've been very busy, Jan! Handmade bunting is so easy to make, isn't it? I've just finished a batch to hang in my garden this summer – but I must remember to bring it in if it rains, or maybe I'll get felt bunting...

THE GIFT OF KNITTING

Thanks so much for my prize – it arrived today! Can't wait to get started. Choosing which garment to knit will be the hardest decision! I've been busy knitting baby gifts (everyone seems to be pregnant just now) and novelty tea cosies for gifts and fairs – these are pyjama cases I did for my nephew and nieces in Thailand. They can double up as cushion covers!

Nikki Duncan, via Facebook

Sophie says: These pyjama cases are brilliant! Such good stashbusting projects. I love the 3D bee and ladybird, and the personalisation. I think I'll be making some of these myself!



this month you tweeted

@thewoolnest
Oh look, it's little old me in @KnitToday

@sincerelylouise
I need to write up my owl necklace pattern so I can share it on my blog! #handmadehour

@LK_Designers
So inspiring to hear from Kaffe Fassett at @RowanYarns event celebrating his contribution to textiles #50yearsofkaffe

@KnittyNadia
To paraphrase Gandalf: All we have to decide is what to knit with the time that is given us. #LOTR #knitting

@Westknits
Afternoon knitting with friends at @loisivethe #westknitsgoestoparis

@knittoday

your say

f THIS MONTH WE ASKED WHERE'S THE STRANGEST PLACE YOU'VE EVER KNITTED?

- ◆ Side stage at rehearsals
Susan Brooke-Smith
- ◆ Sitting under a parasol on a Greek beach. I had to finish the toe off on my newest pair of socks! Definitely got odd looks from fellow sunbathers...
Louise Easterbrook
- ◆ Watching my daughter's street dance class, watching rehearsals for a play and on the train to Harry Potter tour!
Rea Verdon
- ◆ I knit everywhere. Doctor's waiting rooms, cafes... We even have some knit nights in a local cocktail bar!
Gillian Coker
- ◆ Beside a MRI scanner while my husband had a scan.
Catherine May



write in and win!

◆ This month, each reader with a letter printed wins a £15 bundle of luxury yarns for their stash. Don't forget to write to us or show us your makes on Facebook and Twitter for your chance to win gorgeous goodies!

◆ **Write to us at:**
Dear Knit Today, Knit Today, 2nd Floor, Tower House, Fairfax Street, Bristol BS1 3BN, or email us at knittoday@immediate.co.uk



loveknitting

LoveKnitting.com
0845 544 2196

Enter **LOVEKTQ16** at LoveKnitting.com for **15% off your order**

Debbie Bliss
Rialto DK Prints by Debbie Bliss

pattern reviews

Slip into something sleeveless this summer with our selection of the best vest makes

“When summer hits a vest, or tank top, makes a brilliant garden-knitting project”



ROSEE,
EDITOR



Could vanilla yellow be your summer look?

Summer Darling

DROPS DESIGN, AVAILABLE AS A FREE DOWNLOAD

When it comes to summer, there's nothing prettier than a yellow shade next to sun-kissed skin. This gorgeous vest top from Drops Design is worked in Drops Paris Uni Colour 100% cotton in Vanilla (shade 35) – a value-for-money yarn which comes in a jaw-dropping 49 different shades! Worked in the round on 4.5mm circular needles you will get a real sense of achievement as you whip through this neat pattern.

◆ Download from www.garnstudio.com

downloads

Head online for the best of summer bag makes

Raspberry bag by P.S. I Crochet

This fruity-looking crochet bag has a bobble-effect finish and is great for summer outings. Download it for free.

www.ravelry.com/patterns/library/raspberry-bag



Stripy beach bag by Heidi Kirmaier

Stripy shoulder bags like this one make a great throw-it-all-in option! Find the free pattern at

www.ravelry.com/patterns/library/medano-beach



Chunky textured bag by Drops Design

Work this bag in a weekend using a textured stitch, big needles and a chunky yarn.

www.garnstudio.com



Praise
MARIE WALLEN
(TAKEN FROM ROWAN BOOK 55), £12.50

Glam up for summer with soft, delicate yarn. This floaty tank top is a mix of Rowan Kid Silk Haze Ghost (shade 642) and Cotton Glacé Dawn Grey (shade 831) and worked in 36-row alternate-yarn stripes. Not for beginners, this intermediate knit is created using a lacy diamond pattern and comes in sizes small to extra large. With Rowan's extensive yarn range you can mix and match your colour choices to suit your wardrobe needs.

◆ From www.johnlewis.com



Anise Acoustic
LOUISA HARDING
(TAKEN FROM ANISE BOOK), £7.15

We're enjoying the summer chunky-knit trend this year. This sweet short vest by Louisa Harding uses her Anise (£4.95 per 50g ball) variegated yarn, where a 4in tension square works up to a chunky 14 stitches and 20 rows! But despite its bulk, being 45% cotton means Anise is ideal for the warmer weather. Designed and knitted using just three balls of Clove (shade 501) this vest is a quick, cost-effective make for everyone.

◆ From www.celticove.com



Lagoon Top
KIM HARGREAVES
(TAKEN FROM ECHOES BOOK), £17.91

Are you an absolute beginner or partial to an easy knit? Then this great summer vest could be for you. Kim Hargreaves' Lagoon pattern is a simple, draped top worked in quick garter stitch throughout. Knitted in Rowan Cotton Lustre (made up of 55% cotton, 35% modal and 10% linen) it makes a refreshingly cool knit to wear on the hottest of days. This version is worked in delightful Sweetpea (shade 379).

◆ From www.kimhargreaves.co.uk

SKILL LEVEL



EASY

TECHNIQUES

- ◆ RAGLAN
- ◆ BUTTONHOLES

KNIT TODAY
WOMEN'S GARMENT

Summertime cardigan

Embrace the lovely mottled look that only variegated yarns can deliver with our raglan-sleeved cardigan

By *Rico*

Pattern info



“Rico Fashion Colour Pop yarns make us think of sweet shop shelves – gorgeous!”



SOPHIE,
OPERATIONS
EDITOR

Living in the UK means being prepared for all weathers, even during the summer, and that's where great cotton cardigans like this one come in handy. Perfect for keeping unexpected breezes at bay, it's a simple make with great results. Not a fan of the Blue Mix? Don't worry, Rico Fashion Colour Pop Double Knitting comes in Yellow, Brown, Red, Purple and Green Mixes too!

Materials

- ◆ Yarn
7 (9:10:11) x 50g balls in Rico Fashion Colour Pop DK Blue Mix (shade 006)
- ◆ Needles
1 pair of 4mm (UK 8, US 6)
1 pair of 3.75mm (UK 9, US 5) knitting needles

- ◆ Accessories
6 buttons

Yarn detail

- ◆ Rico Fashion Colour Pop DK
www.rico-design.de
- ◆ DK
- ◆ 100% cotton
- ◆ 50g/110m (120yds)
- ◆ Machine wash at 30°C
- ◆ £3.49

Tension

22 sts and 28 rows to 10cm or 4in over st st on 4mm needles.

Pattern notes

Where the figure 0 appears, no sts, times or rows are worked for this size. After casting off, one stitch will remain on the right-hand needle which is not included in following instructions.

- ◆ Turn to page 92 for full list of abbreviations



Pattern from Leaflet 308: Rico Fashion Colour Pop DK, £4.95
www.loveknitting.com

SUMMERTIME CARDIGAN BACK

Using 3.75mm needles and thumb method **cast on** 103 (115:127:137) sts.

Row 1 (RS): *K1, p1, rep from *to last st, k1.

Row 2 (WS): P1, *k1, p1, rep from * to end.

Row 3: *P1, k1, rep from *to last st, p1.

Row 4: K1, *p1, k1, rep from *to end.

These 4 rows will now be called Irish moss st. Work 5 rows more in Irish moss st.

Row 10: Purl to end dec 4 sts evenly across row. 99 (111:123:133) sts

Change to 4mm needles and work as follows:

Row 1: Knit.

Row 2: Purl.

Last 2 rows form st st.

Continue in st st until back measures 28 (28:30:32) cm, 11 (11:11¾:12½) in, ending with a WS row.

SHAPE RAGLAN

Cast off 5 sts at beg of next 2 rows.

89 (101:113:123) sts

Work 12 (16:26:28) rows, dec 1 st at each end of every row. 65 (69:61:67) sts

Work 34 (36:28:30) rows, dec 1 st at each end of next and every foll alt row.

31 (33:33:37) sts

Cast off rem 31 (33:33:37) sts.

LEFT FRONT

Using 3.75mm needles and thumb method **cast on** 49 (55:61:65) sts.

Work 9 rows in Irish moss stitch as given for Back.

Row 10: Purl to end dec 3 (3:3:2) sts evenly across row. 46 (52:58:63) sts

Change to 4mm needles cont in st st until left front measures 28 (28:30:32) cm, 11 (11:11¾:12½) in, ending with a WS row.

SHAPE RAGLAN

Next row (RS): Cast off 5 sts, knit to end. 41 (47:53:58) sts

Next row (WS): Purl.

Work 12 (16:26:28) rows, dec 1 st at raglan edge in every row. 29 (31:27:30) sts

Work 27 (29:21:23) rows, dec 1 st at raglan edge in next and every foll alt row. 15 (16:16:18) sts

SHAPE NECK

Next row (WS): Cast off 7 (8:8:10) sts, purl to end. 8 sts

Work 3 rows, dec 1 st at raglan edge in next and foll alt row AND AT THE SAME TIME dec 1 st at neck edge in every row. 3 sts
Work 2 rows, dec 1 st at raglan edge only in 2nd row. 2 sts

SIZING GUIDE		8-10	12-14	16-18	20-22
TO FIT BUST	cm	81-86	91-97	102-107	112-117
	in	32-34	36-38	40-42	44-46
ACTUAL BUST	cm	90	101	111	121
	in	35½	39¾	43¾	47¼
FULL LENGTH	cm	50	52	56	59
	in	19¾	20½	22	23¼
SLEEVE LENGTH (¾ LENGTH)	cm	28	28	29	30
	in	11	11	11.5	11¾

Next row (WS): P2tog.
Fasten off.

RIGHT FRONT

Using 3.75mm needles and thumb method cast on 49 (55:61:65) sts.

Work 9 rows in Irish moss stitch as given for Back.

Row 10: Purl to end dec 3 (3:3:2) sts evenly across row. 46 (52:58:63) sts

Change to 4mm needles. Cont in st st until right front measures 28 (28:30:32) cm, 11 (11:11¾:12½) in, ending with a RS row.

SHAPE RAGLAN

Next row: Cast off 5 sts, purl to end. 41 (47:53:58) sts

Work 12 (16:26:28) rows dec 1 st at raglan edge in every row. 29 (31:27:30) sts

Work 26 (28:20:22) rows dec 1 st at raglan edge in next and every foll alt row.

16 (17:17:19) sts

SHAPE NECK

Next row (RS): Cast off 7 (8:8:10) sts, knit to last sts, k2tog. 8 sts

Next row (WS): Purl.

Work 3 rows, dec 1 st at neck edge in every row, AT THE SAME TIME dec 1 st at raglan edge in next and foll alt row. 3 sts

Work 2 rows dec 1 st at raglan edge only in 2nd row. 2 sts

Next row (WS): P2tog. Fasten off.

SLEEVES (BOTH ALIKE)

Using 3.75mm needles and thumb method cast on 55 (57:59:61) sts.

Work 9 rows in Irish moss stitch as given for Back.

10th row: Purl to end dec 2 sts evenly across row. 53 (55:57:59) sts

Change to 4mm needles and work in st st inc 1 st at each end of 5th and every foll 4th (4th:2nd:2nd) row to 71 (79:69:71) sts.

Inc 1 st at each end of every foll 6th (6th:4th:4th) row to 79 (83:93:97) sts.

Cont without shaping until sleeve measures 28 (28:29:30) cm, 11 (11:11½:11¾) in, ending with a WS row.

SHAPE RAGLAN

Cast off 5 sts at beg of next 2 rows. 69 (73:83:87) sts

For 2nd size only

Work 4 rows, dec 1 st at each end of 1st row. (71) sts

For 3rd and 4th sizes only

Work 4 rows, dec 1 st at each end of every



Avoid wonky buttons by measuring the spacing carefully before securing

row. (75:79) sts

For all sizes

Work 46 (48:50:54) rows, dec 1 st at each end of next and every foll alt row.

23 (23:25:25) sts

Cast off rem 23 (23:25:25) sts.

RIGHT FRONT BORDER

With RS facing, using 3.75mm needles pick up and knit 8 sts evenly up Irish moss stitch and 89 (95:103:109) sts evenly up front edge. 97 (103:111:117) sts.

Beg with 2nd row Irish moss stitch as given for Back work 4 rows.

Next row: Patt 2 (3:2:3), cast off 1 st, [patt 16 (17:19:20), cast off 1 st] 5 times, patt 3 (3:2:2).

Next row: Patt 4 (4:3:3), cast on 1 st, [patt 17 (18:20:21), cast on 1 st] 5 times, patt 2 (3:2:3).

Work 4 more rows in Irish moss stitch.

Cast off in patt on WS.

LEFT FRONT BORDER

With RS facing, using 3.75mm needles pick up and knit 89 (95:103:109) sts evenly down front edge and 8 sts evenly down Irish moss

stitch. 97 (103:111:117) sts

Beg with 2nd row Irish moss st as given for Back work 10 rows.

Cast off in patt (on WS).

COLLAR

Join raglan seams. With RS facing, using 3.75mm needles and beg halfway across right front border pick up and knit 20 (21:21:23) sts evenly up right side of neck, 15 (15:17:17) sts from top of right sleeve, 23 (25:25:29) sts from back of neck, 15 (15:17:17) sts from top of left sleeve and 20 (21:21:23) sts evenly down left side of neck, ending halfway across left front border.

93 (97:101:109) sts. Beg with 2nd row Irish moss stitch as given for Back work for 7cm, 2¾in, ending with a WS row. Cast off in pattern.

TO MAKE UP

Join side and sleeve seams.

Sew on buttons.

Pin out cardigan to the measurements given. Cover with clean, damp tea towels and leave until dry.

See ball band for washing and further care instructions. 

3 ISSUES FOR £5

when you subscribe today!

EXCLUSIVE!
8 PRETTY PAPERS

KNIT • PAINT • SEW • CRO

FREE!
STAR HOOP STITCH KIT
PLUS PAPERS

KNIT • STYLE • ORIGAMI • WEAVE • CROCHET

FREE!
DREAMCATCHER CROCHET KIT
PLUS 8 PAPERS

Etsy TAKEOVER! 18 PROJECTS + TIPS FOR SELLING

34
SWEET STITCHES
PAGE 94

EASY-SEW KIMONO
PAGE 66

LIVING A CREATIVE LIFE

MAKE IT!
CROCHET FLOWER SCARF
DOTTY SNAP PUR
POM POM KN
PAPER BLANI
FLOWER DISPI
AMIGURU
SPRING BIRD
ELECTRIC B
FRINGE NECK

MAKE IT!
CROCHET MANDALAS
MACRAME PLANTERS
TURN A SHIRT INTO A SUMMER SKIRT
KNIT A CACTUS
UNICORN CUSHION
HOBBYHORSE
HOT DOG EYE MASK
ORIGAMI SHADE
CKLACE

EASY-SEW
HANDMADE Summer

QUITY!

3 ISSUES FOR JUST £5
DELIVERY DIRECT TO YOUR DOOR
SAVE MONEY ON THE SHOP PRICE
FREE GIFT EVERY ISSUE
EXCLUSIVE PROJECT FOR SUBSCRIBERS

<http://craft.buysubscriptions.com/MMSP3D>

Call +44 1604 828740 and quote reference code MMSP3D

Lines open 8am-9.30pm weekdays, 8am-4pm Saturdays

Terms & Conditions: This offer is for new print subscribers only subscribing by Direct Debit. You will receive 3 issues for £5 and then continue on a 6 monthly Direct Debit of £24.49 thereafter. Full details of the Direct Debit guarantee are available on request. Prices correct at point of print and subject to change. Offer ends 31st August 2015



www.molliemakes.com



facebook.com
/MollieMakes



@MollieMakes



MollieMakes



pinterest.com
/MollieMakes



youtube.com/user
/MollieMakes

WorldMags.net

great reads

Learn crochet and colourwork, plus create clothes for yourself and cute gifts

“Layering under knitted vests gives you flexible style – 30 designs means you have plenty of choice too”



Vest Bets
THE EDITORS OF SIXTH&SPRING BOOKS £12.99

Before you rule out knitting all 30 designs in this collection, wait until you see them! There's such a mix of styles. Some loose, some snug, some turtle-necked, some textured – every style imaginable, in 220 Superwash Aran from Cascade Yarns. They're for knitters of all abilities from beginner to experienced – we think an adventurous intermediate knitter could complete even the trickiest.

◆ Sixth&Spring, paperback, 144 pages, ISBN 978-193609-681-7

brilliant bloggers

These bloggers will get you knitting all day, every day

www.apicturebookmind.blogspot.be

Enjoy the intricacies of the designing process as Belgian knitter, Ine, mixes up her love of the outdoors, photography, drawing and knitting. Her love of nature is reflected in her wonderful stories, designs and stunning yarn choices.



www.knitta.com

Enjoy the mash-up of knitted wonder which is Knitta.com. Skipped by Magda Sayeg, this visual blog delight will boost your knitting desires and inspire you with its world of wonderful things. Fun, bold and very visual, Knitta.com boosts flagging creative mojos.



www.coopknits.co.uk

We love the chit-chat nature of this fun website buzzing with knits (mainly socks), and advice. With gorgeous images and everything yarn based and fashion fabulous, it's a real pleasure to browse.

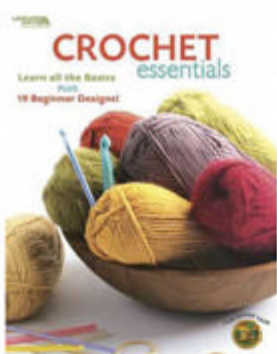

Crochet Essentials
LION BRAND YARN £5.99

If you've yet to master the art of crochet, this book could be your perfect partner. It teaches the very basics of crochet and has some simple projects using the easiest stitches. There's a scarf, bag, shrug and vest, plus homewares like dishcloths and cushions, as well as gifts for baby... and your four-legged friends! Some of the 19 patterns are similar – the dog and cat mat, for example – but there's enough variety that you'll find something you're keen to recreate.

◆ Leisure Arts, paperback, 40 pages, ISBN 978-1-60140-113-7



Colorwork Knitting
SARAH E WHITE £14.99

Want to create knits alive with colour? Sarah's book will guide you. Learn five different colourwork techniques: striping, striping with self-striping yarn, slip stitch, stranded and intarsia. The instructions are every bit as clear as a fledgling colourworker would hope, with step-by-steps. After your colourwork 'course', you'll be savvy enough to choose your own winning colour combinations too, perhaps in one of these 25 patterns for socks, scarves, gloves and more.

◆ Stackpole Books, paperback, 114 pages, ISBN 978-0-81171-414-3



Knitted Rabbits
VAL PIERCE £9.99

Knitted rabbits are often the toy of choice for children, so it makes sense to have a stash of good patterns! Val comes to the rescue with her collection of bunnies, some classic, some quirky, but all undeniably cute. Each pattern has a shopping list and useful notes to guide you through the making process. As you'd expect from such a renowned knitting author, Val explains everything so clearly, and her passion for knitting shines through in her adorable patterns.

◆ Search Press, hardback, 96 pages, ISBN 978-1-84448-867-4

TRY 3 ISSUES FOR ONLY £5!

when you subscribe to **CrossStitch
crazy**



Bursting with fun, *Cross Stitch Crazy* is packed full of easy-to-follow charts that are quick to stitch, from all your favourite designers. With fun stories, great competitions and a fab free gift with every single issue, you'd be mad to miss it! Plus, with our special offer, you can **subscribe today and try three issues for just £5!**

Yvette

Yvette Streeter, Editor

GREAT REASONS TO SUBSCRIBE

- ♥ **JUST £5** for three issues!*
- ♥ Continue with a **33% DISCOUNT** – just £19.99 every six issues
- ♥ **FREE UK** delivery – never miss an issue
- ♥ **FREE BONUS** gift with every issue
- ♥ **BONUS** subscriber-only competitions, charts and giveaways

ORDER FORM

C795

- Yes, I would like to subscribe to *Cross Stitch Crazy* with the special offer of **three issues for just £5** then £19.99 every six issues by Direct Debit

**SAVE
67%**

YOUR DETAILS

Title _____ First Name _____

Surname _____

Address _____

Postcode _____

Telephone number _____

Email address _____

- I would like to send a gift subscription (please attach a separate sheet with the address, email and telephone details of the recipient if you are giving a gift subscription)

This offer ends 31st December 2015

*This offer is only available to UK residents paying by Direct Debit and is subject to availability. After your first three issues, your subscription will continue at just £19.99 every six issues, saving you 33% on the shop price. If you cancel within two weeks of receiving your second issue, you will pay no more than £5. Your personal information will be used as set out in our Privacy Policy, which can be viewed at immediate.co.uk/privacy-policy

INSTRUCTION TO YOUR BANK OR BUILDING SOCIETY TO PAY BY DIRECT DEBIT



To: The Manager/bank/building society

Name of bank _____

Address _____

Postcode _____

Name(s) of account holders _____

Bank/building society account no. _____

Branch sort code _____

Instruction to your bank/building society

Please pay Immediate Media Company Bristol Ltd Direct Debits from the account detailed in this instruction subject to the safeguards assured by the Direct Debit Guarantee. I understand that this instruction may remain with Immediate Media Company Bristol Ltd and, if so, details will be passed electronically to my Bank/Building Society.

Signature(s) _____

Date _____

OFFICE USE ONLY

Reference Number _____

Originator's Identification Number

8 3 6 8 3 9

Banks and building societies may not accept Direct Debit instructions for some types of accounts

3 EASY WAYS TO ORDER



Order online at www.buysubscriptions.com/crazy
and enter code **C795**



Call now on **0844 844 0385**
quoting code **C795**
Lines open weekdays 8am to 8pm and
Saturday 9am to 1pm



Order by post

FREEPOST IMMEDIATE MEDIA
(Please use capitals. UK only)

SORT OUT YOUR shaping



With many patterns giving only vague instructions for shaping, it can be hard to know what to do. *Rosee Woodland* looks at some options for decreasing...

So, you've reached a point in a project where you're told to 'decrease at each end of the row' but nothing more – how do you decide which method to use? Whether you're a beginner or an expert (or somewhere in between!) it's worth considering your options before diving in with a 'k2tog' decrease. Read on for tips on how to make your shaping that bit neater.



LEFT, RIGHT, LEFT!

Before we start looking at left and right-leaning decreases, consider this one tip to make your shaping neater. Where a pattern gives the instruction to decrease at the beginning and end of a row, try working one stitch in instead. Not only does this give a more defined edge to your work (you can see this technique in all the swatches on this page where they change from stocking stitch to moss or garter stitch), it also makes sewing up much easier.

If you look at a bought jumper you will probably find that the shaping has been made several stitches in from the edge of the knitted fabric. Known as 'fully fashioned shaping', this technique makes a design feature of the shaped stitches rather than trying to hide them away.

Whether you choose to tuck your shaping into the edge of your fabric, or make it more obvious, it's worth knowing that different decreases lean in different

Fully fashioned shaping makes a design feature of the shaped stitches

directions. A k2tog decrease leans right in the knitted fabric, so you would probably use it at the left-hand edge of the fabric (with right side facing you). To mirror it at the opposite edge, use an ssk (short for slip, slip knit) decrease (see image 1 for use of both stitches). Left-leaning decreases like ssk are never quite as tidy, as the stitches are slightly baggier, but there is a trick you can use to make ssk a little neater.

For the ssk decrease, you are normally told to slip the first two stitches on your LH needle knitwise, one at a time, and then knit them

TURN
OVER FOR
STEP BY
STEPS

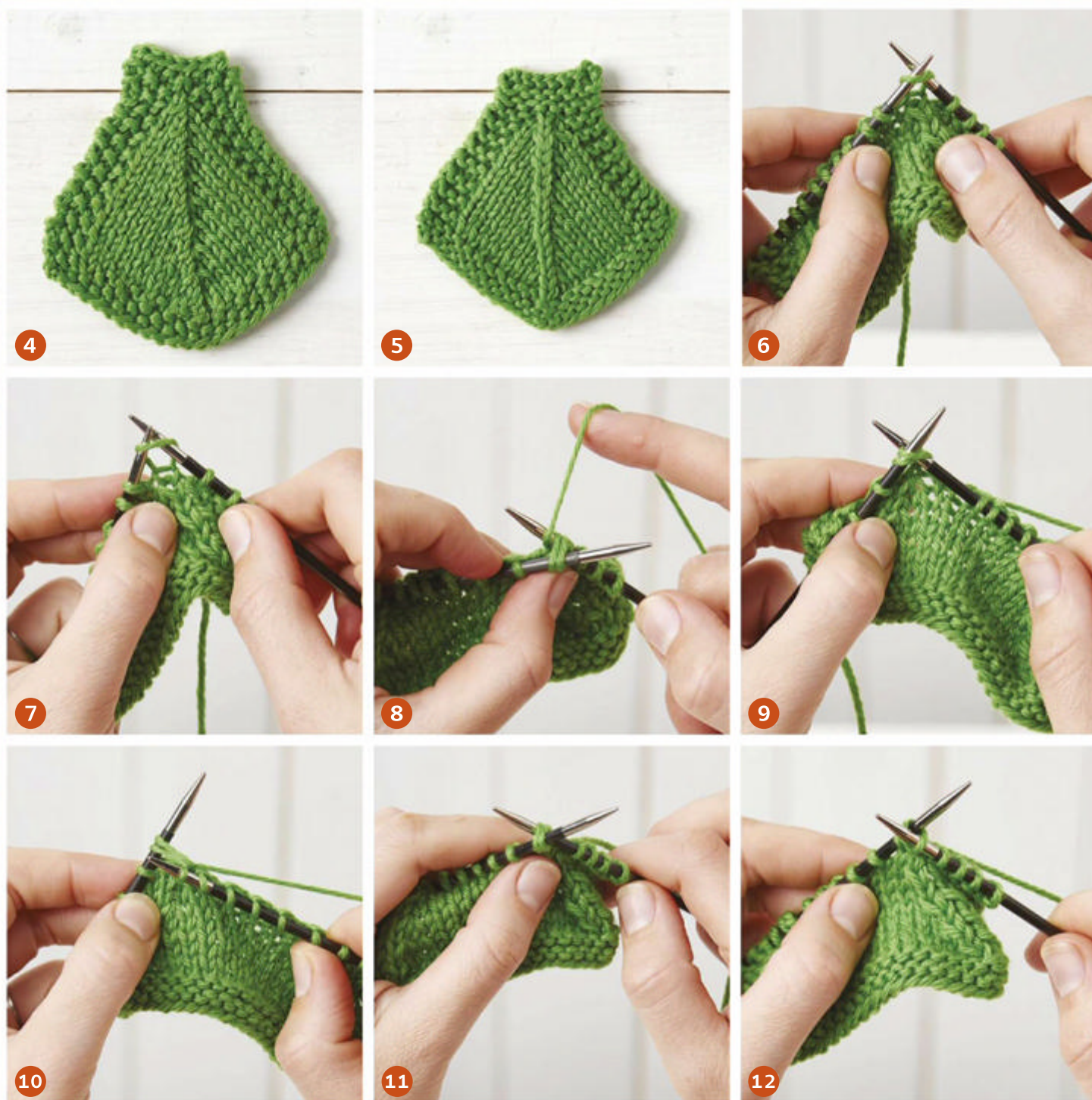

together through the back loops. In fact, this twists the second stitch unnecessarily, making the decrease more obvious. Instead, slip only the first stitch knitwise **6**, then place it back on the LH needle without twisting it **7**. Now knit these two stitches together through the back loops **8**.

Where a pattern gives *sl1, k1, pssso*, we would recommend using *ssk* instead, as it's a little bit neater.

To work *k2tog*, you need to place your right-hand needle through the first two stitches on your LH needle **9** and knit them together as normal **10**.

You'll find that many older patterns give an alternative left-leaning decrease, *k2togtbl* (knit two together through the back of the loops). This gives a more pronounced but slightly tighter left-leaning decrease. It should be partnered with the right-leaning decrease *ksp* (knit, slip, pass). Both these are used in the swatch in image 2 on page 49.

For *k2togtbl*, place your RH needle through the back of the first loops on the LH needle **11** and knit the two stitches together **12**. To work the right-leaning *ksp* decrease, knit the first stitch on your

LH needle, pass it back to the LH needle purlwise **13**, slip the second stitch on the LH needle over the first **14**, and then move this stitch purlwise (ie. without twisting it) onto your RH needle **15**.

Where a pattern tells you to make a double decrease, you often do this in the middle of a row, so that the decrease, which tends to be more obvious, is nicely centred. You could use a left-leaning double decrease (*sl1k2togpssso*), shown here in image 3; a right-leaning decrease (*k3tog*) **4** or a centred double decrease (*sl2k1pssso*, sometimes given as *cdd*), **5**.



13

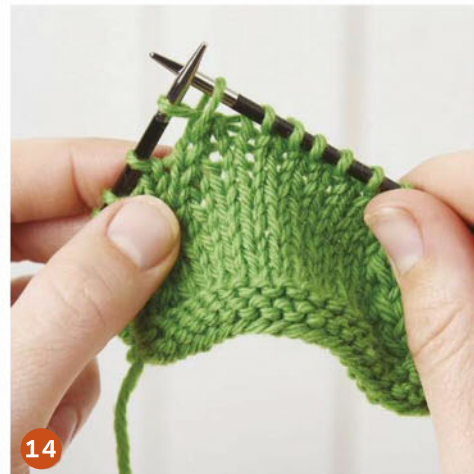

14



15



16

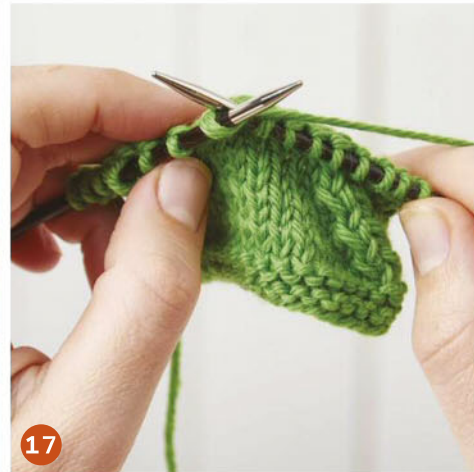

17



18



19



20



21

For the left-leaning double decrease, slip the first stitch on your LH needle knitwise to your RH needle **16**. Knit the next two stitches on the LH needle together **17**. Now pass the slipped stitch over the k2tog you've just made **18**.

The k3tog, which leans right, is the simplest of the three double decreases. Treat it like a k2tog, but put your RH needle through the first three stitches on your LH needle, instead of the first two, and knit them all together **19**.

If you want to create a perfectly centred double decrease, slip two stitches together

knitwise from your LH needle **20**, knit the next stitch **21** and then pass the two slipped stitches over **22**.

As you can see, all the options we have given you will give a slightly different end result, and there may be one in particular you prefer. For lace patterns you are normally given a specific instruction, and we'd recommend following lace decreases exactly. But if the pattern is unclear, or if you don't like the decrease it's giving you, try swatching to see what different decreases look like in your finished fabric and make your own mind up instead! 



22

YOUR FAVOURITES FROM
Simply
Crochet



CUTE CREATURES TO CROCHET

Amigurumi

COLLECTION



Packed with super-cute collectable crochet creatures, *Amigurumi Collection* is perfect for all crochet lovers! From cats and dogs to dolls and dragons, every project is beautifully photographed and carefully explained. And with our handy step-by-step guide to basic stitches, even beginners can follow every pattern and make these adorable crocheted companions!



ORDER YOUR COPY TODAY!

ORDER ONLINE www.buysubscriptions.com/craftspec15
OR CALL 01604 828744 and quote 'Amigurumi Collection'

Lines open weekdays 8am to 9.30pm and Saturday 8am to 4pm.

Overseas please call +44 (0) 1604 828744.

* EUR price £9.99, ROW price £10.99. All prices include P&P. Please allow up to 28 days for delivery.

WorldMags.net

SKILL LEVEL



INTERMEDIATE

TECHNIQUES

- ◆ SHAPING
- ◆ KNITTING IN THE ROUND

EXCLUSIVE
KNIT TODAY PATTERN

Cosy fingers & toasty toes

Keep baby snugly warm with this gorgeous knitted set in sweet pink

By **Julie Ferguson**



“Packed with cute-factor, mittens and booties make the perfect quick-knit gift for a new arrival”



ROSEE,
EDITOR

Phildar's Merinos Alpaga is a very soft choice suitable mainly for lighter garments. Made up of 70% wool and 30% alpaca, this amazing, breathable yarn will keep baby cosy but not too hot. Worked on 3mm needles it knits up into a wonderfully pliable but dense finish that's satisfyingly neat and tidy. Thankfully, this dreamy yarn is also machine washable which will certainly please mum!

Materials

- ◆ Yarn
2 x 25g balls (for set)

Phildar Merinos Alpaga in Rose (0012)

- ◆ Needles
1 pair of 3mm (UK 11, US 3/2) knitting needles
A 3mm (UK 11, US 3/2) crochet hook
Tapestry needle
- ◆ Accessories
4 buttons
4 bows (optional)
Stitch holder

Yarn detail

- ◆ Phildar Merinos Alpaga
www.deramores.com
- ◆ 70% wool, 30% alpaca
- ◆ 25g/57m (62yds)
- ◆ Machine wash 30°C
- ◆ £3.69 per ball

Tension

28 sts and 40 rows over 10cm or 4in in pattern using 3mm needles.

Measurements

To fit 0 – 3 months

Abbreviations

- sl1p** slip 1 stitch from the left needle to the right purlwise
- slp** slip 1 stitch from the left needle to the right knitwise

◆ Turn to page 92 for a full list of abbreviations

sl1, k1, pss0, yfwd, sl1p, yb, k1, yfwd, sl1p, yb, K1, k2tog, (k1, yfwd, slp, yb,) 9 times, k1. 43 sts

Next row: K1, (yfwd, sl1p, yb, k1) 9 times, sl1, k1, pss0, k1, k2tog, (k1, yfwd, slp, yb) 9 times, k1. 41 sts

Next row: Sl1, k1, pss0, (k1, yfwd, sl1p, yb) 8 times, k1, k3tog, (k1, yfwd, slp, yb) 8 times, K1, k2tog. 37 sts

Next row: K7, cast off 23 sts, k7.

Break yarn **

Slip first 7 sts onto a stitch holder.

Rejoin yarn to remaining 7 sts, cast on 16 sts to make strap.

K16, then K7, then K7 from stitch holder to join shoe at back heel. 30 sts
Knit 1 row.

Make buttonhole in strap.

Next row: K2tog, yo, knit to the end of the row.

Knit 2 rows.

Cast off.

RIGHT SHOE

Work as for left shoe to **

K7, **cast on** 16 sts to make strap, place 7 sts on stitch holder.

K16, then k7, then k7 from stitch holder to join shoe at back heel. 30 sts

Knit 1 row.

Make buttonhole in strap.

Next row: K2tog, yo, knit to the end of the row.

Knit 2 rows.

Cast off.

Sew back heel seam and centre sole seam.

Work 1 row of dc with 3mm crochet hook, along last garter ridge of sole.

Attach buttons and bows.

BABY MITTS

(MAKE TWO ALIKE)

Using 3mm needles, cast on 31 sts.

K 8 rows.

Row 1: K1, *yfwd, sl1p, yb, k1, repeat from * to the end of the row.

Row 2: Purl.

Repeat rows 1 and 2, sixteen more times.

Next row: K1, *k2tog, repeat from * to the end of the row. 16 sts

Next row: Purl.

Next row: *K2tog, repeat from * to the end of the row. 8 sts

Next row: Purl.

Break yarn, thread through remaining stitches, pull up tightly and finish off.

Sew side seams.

Attach buttons and bows.

Repeat rows 1 and 2 twice more.

Purl 1 row.

SHAPE TOP OF SHOE

Next row: K1, (yfwd, sl1p, yb, k1) 9 times, sl1, k1, pss0, (yfwd, sl1p, yb, k1) 4 times, yfwd, sl1p, yb, k2tog, (k1, yfwd, slp, yb,) 9 times, k1. 49 sts

Next row and every alternate row: Purl.

Next row: K1, (yfwd, sl1p, yb, k1) 9 times, sl1, k1, pss0, k1, (yfwd, sl1p, yb, k1) 3 times, k2tog, (k1, yfwd, slp, yb) 9 times, k1. 47 sts

Next row: K1, (yfwd, sl1p, yb, k1) 9 times, sl1, k1, pss0, (yfwd, sl1p, yb, k1) twice, yfwd, sl1p, yb, k2tog, (k1, yfwd, slp, yb) 9 times, k1. 45 sts

Next row: K1, (yfwd, sl1p, yb, k1) 9 times,



Worried about scratches?
Remove the buttons or
replace with ribbon or
Velcro fastening



Purl
OF WISDOM

There's a lot going on in most rows of this knitted set so follow the repeats and check when to knit from your stitch holders for happy results.

Prevent your decorative ribbons fraying by adding a small dab of clear nail varnish to the ends

BONNIE *babies*

A baby born prematurely is a difficult time for every parent, so here's how you can help...By *Kirstie Sleight*

Helping others in their time of need is how Debby Lamont, 50, from Campbeltown in Argyllshire coped with her own heartbreak. Debby founded Bonnie Babies 15 years ago, knitting tiny premature baby clothes, blankets and burial outfits for Special Care Baby Units and parents across the country. "I created the charity to cope with my own losses and named it Bonnie Babies in memory of my own," says Debby. "In 2000 I sent the first ever parcel of tiny knitted blankets, cardigans and bonnets to the Southern General Hospital in Glasgow and the charity has grown from there."

Bonnie Babies supports around 200 of the UK's Special Care Baby Units, bereavement units and

"Last year Debby sent out an amazing 100,352 items made by supporters"

hospices, as well as the Still Birth and Neonatal Birth Society (SANDS) and the Simpsons Memory Box Appeal (SIMBA), supplying tiny handmade teddies, hats, booties, blankets and keepsakes. Last year alone Debby was able to send out an amazing 100,352 items made by supporters.

"I have lost track of just how many knitters, crocheters, stitchers and friends have supported Bonnie Babies over the last 15 years but there must be hundreds from all over the world. Many send regularly and it's lovely to receive their parcels with a letter to

hear how they are getting on."

Bonnie Babies has also sent knitted items to Rwanda, Zambia, Uganda,

Nairobi and Ethiopia, mostly through British doctors and nurses who take items out with them when they can. Last December, Debby was able to offer support close to home when the daughter of one of her oldest friends gave birth to her son seven weeks early. Lucas Peter John Kearney weighed 4lb 9oz but is now home with mum, Karen and dad, Michael, and doing well. "I was very proud to dress Lucas," says Debby, "and I've had a few lovely cuddles, too!"

◆ To support Bonnie Babies, send items and any yarn or fabric to: Bonnie Babies, Units 8 & 9, Hazelburn Business Park, Campbeltown, PA28 6HA. Visit www.bonniebabies.co.uk for patterns. 



From top: Debby in her packing room holding a Christening shawl knitted by a Bonnie Babies friend; items ready to be sent out; Lucas Kearney in a Bonnie Babies' outfit – born seven weeks early, he is now safely home



NEW!

WEEKEND Quilting

PATCHWORK PROJECTS FOR SIMPLE, CHILLED-OUT SEWING



ONLY
£7.99

Bursting with feel-good projects, *Weekend Quilting* is perfect for fabric lovers of all abilities. Whether you fancy a quick patchwork gift, on-trend homestyle, stylish accessories or even a bigger project to while away the hours, we've got designs from the biggest names in modern quilting to get you feeling inspired to sew!

FROM THE MAKERS OF

LOVE PATCHWORK & Quilting



BUY YOUR COPY NOW!

ORDER ONLINE www.buysubscriptions.com/craftspec15
OR CALL 01604 828744 and quote 'Weekend Quilting'

Lines open weekdays 8am to 9.30pm and Saturday 8am to 4pm. Overseas please call overseas +44 (0) 1604 828744.
EUR price £10.99, ROW price £11.99. All prices include P&P.

MAYBE *baby*

Keep things kitten soft and modern or wonderfully woolly and retro with these great baby yarns

Sponsored by LoveKnitting
www.loveknitting.com



YOUR HANDY SWATCH PATTERN

LITTLE FOUNTAIN PATTERN

Over multiples of 4 + 1

Row 1 (RS): K1, *yo, k3, yo, k1; rep from * to end

Row 2 (WS): Purl.

Row 3: K2, sl 1, k2tog, pssso, *k3, sl 1, k2tog, pssso; rep from * to last 2 sts, k2.

Row 4: Purl.

Repeat these 4 rows

Note: Sts should only be counted after Row 3 and Row 4

◆ For abbreviations, see page 92

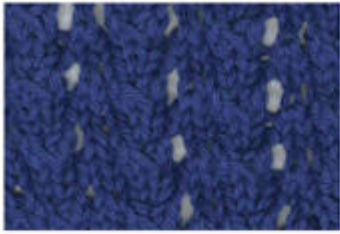

Rico
BABY COTTON SOFT DK

Content: 50% cotton, 50% acrylic
Weight/length: 50g/125m (136yds)
Needle: 3.5mm to 4mm
Shade: Royal Blue (38)
Wash: Machine wash at 30°C
Tension: 33 sts and 44 rows to 10cm or 4in square
Price: £2.55

This great yarn has a reputation for reliability, so expect consistency in colour, texture and quality. There are 30 different colours to choose from, ranging from subtle to bright and bold, with some more unusual baby shades and two mouliné shades that mix white with red or black for a speckled finish. This cotton mix yarn is machine washable and pleasingly soft to the touch.

♦ Visit www.rico-design.de



Patons
FAIRYTALE CLOUD DK

Content: 100% polyester
Weight/length: 25g/82m (76yds)
Needle: 4mm
Shade: Pastel blue (52)
Wash: Machine wash at 40°C
Tension: 33 sts and 44 rows to 10cm or 4in square
Price: £5.60

While you won't use them to show off a stitch pattern, all these fluffy fibres make this the softest yarn on test here. It's quite stretchy so, though it grows quickly, it's best for smaller projects like teddies and hats. It's super-easy to wash as well as being super-soft. Choose from seven shades that are mostly pastel with a few naturals in the mix.

♦ Visit www.makeitcoats.com or call 01484 681881

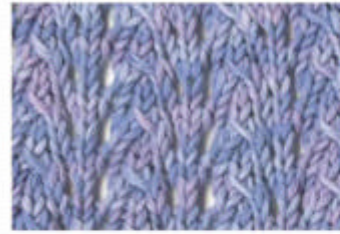

Debbie Bliss
ECO BABY PRINTS

Content: 100% cotton
Weight/length: 50g/125m (136yds)
Needle: 3.25mm
Shade: Mauve (007)
Wash: Machine wash at 30°C
Tension: 25 sts and 34 rows to 10cm or 4in square
Price: £4.99

This new organic cotton yarn comes in 10 variegated colourways in a mix of softly contrasting pastels and funky mixed brights, with frequent colour changes along the yarn for a mottled finish. There's great pattern support with 12 contemporary clothing designs for children of all ages in the accompanying pattern book.

♦ Visit www.designeryarnsuk.com



Peter Pan
CUPCAKE

Content: 50% acrylic, 50% nylon
Weight/length: 50g/90m (98yds)
Needle: 3.75mm to 4.5mm
Shade: Peppermint (830)
Wash: Machine wash at 40°C
Tension: 19 sts and 28 rows to 10cm or 4in square
Price: £2.85

Twisting a thick fluffy thread together with a sheeny, non-stretchy one makes this cloud-soft but stable to knit with. New colours have just been added giving a choice of 17 sugary shades that are good enough to eat, all fluffy white with coloured sheens. This is a great yarn for toys or cosy knits like matinee jackets, dressing gowns or hats.

♦ Visit www.tbramsden.co.uk or call 01943 872264

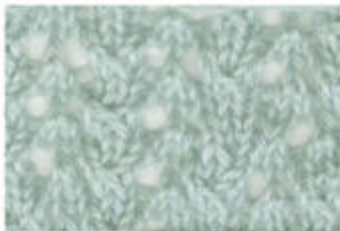

Susan Crawford Vintage
EXCELANA DK

Content: 100% wool
Weight/length: 50g/119m (130yds)
Needle: 3.75mm to 4mm
Shade: Nile Green
Wash: Hand wash
Tension: 22 sts and 28 rows to 10cm or 4in square
Price: £4.99

Though not specifically a baby yarn, this wool uses a mix of 70% Exmoor Blueface and 30% Blue Faced Leicester to make this a less scratchy option if you want a pure wool yarn. It's softly spun with a little give in the fibre for comfort, but still with good definition for patterns or cables. Powdered Egg yellow would also be a good choice for a baby knit.

♦ Visit www.excelana.com or call 01598 752490



King Cole
COTTON SOFT DK

Content: 100% cotton
Weight/length: 100g/210m (229yds)
Needle: 4mm
Shade: Buttercup (1600)
Wash: Machine wash at 40°C
Tension: 22 sts and 28 rows to 10cm or 4in square
Price: £4.49

It's not hard to see why this is such a popular yarn – silky to the touch, machine washable and in 26 essential colours, it's robust enough for childrens' clothes even though it does not feel like it is! Perfect for warm weather knits and soft enough to be worn right next to baby's skin, try it for knitted vests and summer dresses.

♦ Visit www.kingcole.co.uk or call 01535 650230



Sirdar
SNUGGLY SPOTS DK

Content: 55% nylon, 45% acrylic
Weight/length: 50g/165m (179yds)
Needle: 4mm
Shade: Busy Lizzie (701)
Wash: Machine wash at 40°C
Tension: 22 sts and 28 rows to 10cm or 4in square
Price: £3.33

This new yarn has all the charm of much-loved Snuggly – machine washable, super soft, great supporting pattern range – but with the added fun of a pretty spot pattern! It launches with six softly patterned yarns, five of which are cream with colour spots, but Cherry Blossoms (705) has a pale pink background colour with lilac and violet spots. Cuddle up!

♦ Visit www.sirdar.co.uk or call 01924 371501

NOW TRY THIS!



Turn to page 53 for these tiny mittens and matching booties. They're the perfect way to welcome the very newest arrivals to the world!

Sponsored by LoveKnitting
www.loveknitting.com

READER OFFER

Get 15% off ALL THESE YARNS!*

Quote code LOVEYR4 when you go to www.loveknitting.com or call 0845 5442196.

Offer ends July 20, 2015.
*Where yarns specified are available.



**RHIAN
DRINKWATER**

"I love variegated yarns, they work particularly well when making socks and seeing the colours change is a pure joy."

SKILL LEVEL



INTERMEDIATE

TECHNIQUES

- ◆ LACY PATTERN
- ◆ GRAFTING

EXCLUSIVE
KNIT TODAY PATTERN

Rainbow tootsies

Love your feet with these
beautifully fancy socks in an easy
lacy stitch
by **Rhian Drinkwater**



Pattern
info

"Knitting socks is a real art, and once tried you'll be surprised at how addictive it is. It's also a great way to use up yarn"



CHARLENE,
ART
EDITOR

Add a little luxury to your sock drawers with these beautiful, patterned yarn socks by wonderful designer, Rhian Drinkwater. Made using Rico Design Superba Cotton Stretch Print in Fuchsia Mix (shade 003), Rhian's unbeatable attention to detail will leave you with a truly professional pair that fits very comfortably. We're sure once made these lovely socks will make you smile every time you pull them on.

Materials

- ◆ Yarn
1 x 100g ball of Rico Design

Superba Cotton Stretch Print in Fuchsia Mix (shade 003)

- ◆ Needles
2.5mm (UK 12/13, US 1/2) circular needles

Yarn detail

- ◆ Rico Design Superba Cotton Stretch Print
www.rico-design.de
- ◆ 4ply weight
- ◆ 41% cotton, 39% wool, 13% polyamide, 7% polyester
- ◆ 100g/420m (459 yards)
- ◆ Machine wash 40°C
- ◆ £7.99

Tension

38 sts and 48 rounds to 10cm or 4in over stocking stitch using 2.5mm (UK size 12/13, US 1/2) circular needles

Finished size

To fit a foot or leg with a circumference of 20 (23:25) cm or 8 (9:10) in.

Special abbreviations

s2kp Slip two stitches together, knit one, pass two slipped stitches over

- ◆ Turn to page 92 for full list of abbreviations

SPECIAL STITCH PATTERN

LACE PATTERN

- Round 1:** (Yo, k2tog, k1, ssk, yo, k3) to end.
 - Round 2:** K to end.
 - Round 3:** (K1, yo, s2kp, yo) to end.
 - Round 4:** K to end.
- Rounds 1 to 4 set pattern.

CUFF

Using 2.5mm needles, **cast on** 56 (64:72) sts. Join to work in the round using the magic loop method, being careful not to twist.

Rounds 1 to 10: (K1tbl, p1) to end.

LEG

Begin working in lace pattern around sock. Continue as established until sock measures approximately 15cm or 6in from cast on.

HEEL

Turn.

Row 1: Sl1 purlwise, p23 (31:31), turn.

Row 2: (Sl1, k1) 12 (16:16) times, turn.

Repeat these two rows 13 (15:17) more times (28 (32:36) rows in total).

Next row: Sl1 purlwise, p14 (18:18), p2tog, p1, turn.

Next row: Sl1, k7, ssk, k1, turn.

Next row: Sl1, p8, p2tog, p1, turn.

Next row: Sl1, k9, ssk, k1, turn.

Continue in this way until all the sts have been used up.

GUSSET

Resume working in rounds as follows:

Next row: Pick up and knit approx 15 (17:19) stitches down left side of flap, place marker (marker1), work across top of foot in lace pattern, place marker (marker2), pick up and knit approx 15 (17:19) stitches up right side of flap.

You should pick up one stitch in every slipped stitch down the sides of the heel flap, then one extra stitch at the join between the heel and the instep stitches. This reduces the likelihood of a hole appearing at this join. It doesn't matter if the exact number you pick up is different to the numbers given above, as long as you pick up the same number on each side.

When knitting the next round, (for this round only), knit the stitches that you picked up at each side of the heel flap through the back loop. This tightens them up and avoids holes in the fabric. For all further rounds, knit these stitches normally.

Dec round: K to 3 sts before marker1, ➔

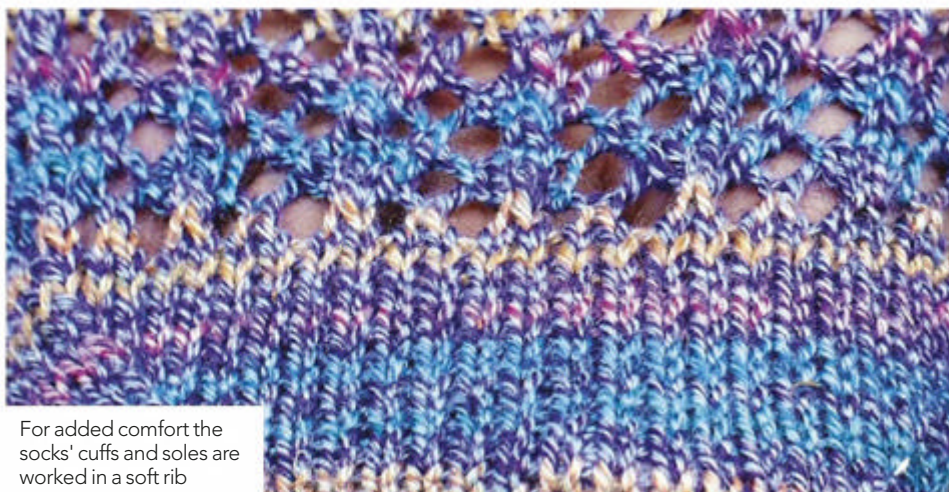

For added comfort the socks' cuffs and soles are worked in a soft rib

LACY SOCKS

k2tog, k1, work across top of foot in pattern to marker2, k1, ssk, k to end.

Plain round: Work in pattern as established. Repeat these two rounds until 24 (32:32) sts remain on sole of foot.

Marker1 marks new start of round.

Continue to work in pattern until foot measures approximately 5cm or 2in less than the desired length, finishing after round 2 or 4 of lace pattern.

TOE

Sizes S and L only

Next round: Remove marker1, k4 (4), place marker1, slip 28 (36) sts, place marker (new marker2), slip 4 sts, remove old marker2, slip sts back to marker1.

This marks new start of round.

All sizes

Dec round: K1, ssk, k to 3 sts before marker2, k2tog, k2 (1 st either side of marker2), ssk, k to 3 sts before marker1, k2tog, k1.

Plain round: Knit.

Dec round: K1, ssk, k to 3 sts before marker2, k2tog, k2 (1 st either side of marker2), ssk, k to 3 sts before marker1, k2tog, k1.

Repeat these two rounds until 20 (24:28) stitches remain. Distribute these so there are 10 (12:14) on each needle tip. Now, 'cast off' 1 stitch at the end of each needle, lifting the very end stitch over the one next to it, then off the needles. This helps to avoid the ends of the toe sticking out in little points once the sock is finished. Graft the remaining 16 (20:24) sts using Kitchener stitch, then weave in all ends. 

Purl OF WISDOM

Not sure how to work Kitchener stitch? Visit www.purlbee.com/2008/01/23/kitchener-stitch/ for a great online tutorial along with handy illustrations.



Fancy a longer sock? Knit to a longer length when working the leg section

Sheep wool is wonderful stuff – it’s breathable, provides instant warmth and even regulates itself to your body temperature – leaving it warm in winter and cool in summer. But what if you just can’t wear it?

For some, wearing wool causes itching, sneezing and red eyes. Others react with a rash and even breathing problems. If that sounds like you then it may be you suffer from a wool allergy or sensitivity.

WHAT IS A WOOL ALLERGY?

Many people have an uncomfortable reaction to wool, but a true wool allergy is caused by an reaction to lanolin, the oil in a sheep’s fleece. Thankfully, lanolin allergies are relatively rare.

“Some people who have the dry, itchy-skin disorder, eczema, find that wool worsens their symptoms. In fact, many people without a skin disorder can find some types of wool scratchy and irritating when worn next to the skin,” says Nina Goad of the British Association of Dermatologists.

A wool allergy is caused by an allergy to lanolin, the oil in a sheep's fleece...and is relatively rare

“Less commonly, people may suffer from a contact allergy to lanolin, the oil secreted from the skin of a sheep to protect its fleece. Most of the lanolin is usually removed from the wool after the sheep is sheared and is modified and used in a range of products including cosmetics. If you have a genuine lanolin allergy, you will experience a rash rather than general itching, and you may need to be patch tested by a dermatologist to confirm the diagnosis and help you learn more about which products contain the type of lanolin to which your skin reacts.”

If you are allergic to lanolin you should avoid knitting with yarns that contain sheep wool and you should also avoid any other products containing lanolin.

On the upside, if lanolin is the problem, most other animals, such as alpacas, llamas, cashmere goats and angora rabbits do not have lanolin in their wool, so knitting with and wearing these fibres should be fine!

THE LONG AND SHORT OF IT

If lanolin isn’t the issue, it may be that symptoms ranging from itchy skin, sneezing and red eyes to breathing difficulties are



Are you allergic to wool?

Ugurhan Betim/Getty Images

Love knitting but can’t touch wool? There are lots of us out there! Luckily there are plenty of alternatives for today’s wool-free knitters...

By *Kirstie Sleight*

WOOL ALLERGIES

caused by an allergy to dust mites in the wool, or to the dyes and chemicals used in the manufacturing process. If this is the case it can be tricky to identify the exact trigger and the solution is often trial and error – patch-testing different yarns to see which ones cause a reaction and which ones don't. In fact, the most common reason for a scratchy feeling when wearing or handling sheep wool, and other animal fibres, is sensitive skin.

Joan Kosmachuk, 52, is a keen knitter but she has never been able to wear any wool against her skin, even as a baby. "A garment with just 1% wool in it is too uncomfortable for me to wear for more than a few seconds," says Joan.

For Joan, the effects of touching any wool are quite severe. "Any area of skin that's come into contact with wool will turn bright red and then itch and burn. It takes a long time for the painful sensation to ease off so I do my best not to touch wool at all."

The most common reason for a scratchy feeling when wearing sheep's wool is sensitive skin

Joan has found that most animal fibres give her the same reaction as sheep wool, although she keeps testing each new option that comes out just in case.

"I've discovered I can knit with some alpaca blends in short spurts without a reaction, but I can't wear alpaca against my skin," she says.

Joan started knitting baby and children's clothes for her nephew and nieces in her early twenties but when she moved on to knitting for adults she was so frustrated with the lack of good yarns for wool-free knitters that she gave up knitting for good... or so she thought.

NEW YARN, NEW HOPE!

Happily, in 2008, a friend persuaded Joan to take up knitting again as there were so many more wool-free yarns available by then.

"My friend encouraged me to read Amy Singer's *No Sheep for You*," says Joan. "I started with a cotton scarf and haven't stopped since!" Soon after, Joan, who now lives in San Francisco, launched her blog woolfreeandlovinknit.typepad.com as a way to connect with more knitters like herself.

"Wool-free knitters tend to get marginalised in the knitting world because our yarn options are more limited," she explains. "It's fun to connect with other

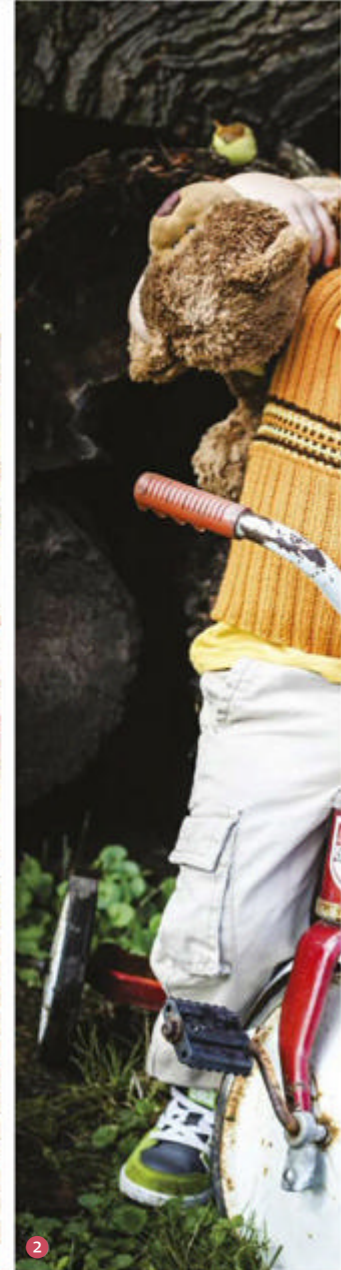

wool-free knitters who enjoy the craft as much as I do, and who get it when I say that I truly cannot knit with wool. That being said, knitters of all kinds visit my blog and I think that's great. What unites us is the love of knitting, not just the fibre we knit with."

Joan now uses mostly plant-based fibre yarns such as linen, hemp, cottons, bamboo and silk or silk blends, with acrylic or acrylic blends for blankets or pillows.

"I have favourite yarns for different things,"

says Joan. "Denim is my choice for sweaters because it washes and wears so well, linen or a linen blend is my current go-to yarn for anything draped. I haven't met a wool-free yarn I wouldn't try at least once!

Unfortunately, many wool-free yarns don't hang around very long, so often a yarn has been discontinued just when I decide it's my new favourite. I find that really frustrating. But then there's always a new wool-free yarn to be tried so I just knit on." 

5 of the best NON-WOOL YARNS

Discover a yarn world free from wool, featuring cotton, silk, bamboo blends and acrylics. Here are 10 of our favourites:



◆ **Stylecraft Malabar**
This is a lovely blend of 78% cotton and 22% silk in an aran weight, which knits up very easily, drapes beautifully and is silky soft on your skin. There are 12 gorgeous colours to choose from ranging from rich brights to pretty pastels and it's machine washable, too!
78% cotton, 22% silk, 100g/165m (180 yards), machine wash at 30°C, £4.99 a ball



◆ **King Cole Bamboo Cotton DK**
This popular non-allergenic yarn is robust yet smooth and great for sensitive skin.
50% bamboo viscose, 50% cotton, 100g/230m (251 yards), machine wash at 30C, £5.59 a ball



◆ **Debbie Bliss Delphi**
Delphi is a chunky 100% cotton tape-style yarn, which knits up quickly on 8mm needles. Delphi is ideal for summer tops and accessories.
100% cotton, 50g/50m (54 yards), handwash, £4.79 a ball



◆ **Sirdar Cotton Rich Aran**
This lightweight, wool-free classic is soft, matt and comes in eight contemporary colours.
60% cotton, 40% acrylic, 100g/200m (219 yards), machine wash at 40C, £4.29 a ball



◆ **Rowan Cotton Lustre**
Cotton Lustre is a clever blend of cotton, linen and modal, which creates a wonderful drape with a very soft handle. This yarn is ideal for quick summer knits and is available in 10 fresh summery shades that are easy on the skin as well as on the eye!
55% cotton, 35% modal, 10% linen, 50g/80m (87 yards), Machine wash at 30C, £5.95 a ball



1 The Six Hour Sweater Knit with Berroco Comfort by Joan Kosmachuk 2 Three Stringed Vest by Joan Kosmachuk, pattern available on Ravelry 3 Tree of Life knitted in Berroco Comfort by Joan Kosmachuk 4 Cable Pillow by Joan Kosmachuk 5 Joan Kosmachuk wearing her Easy Folded Poncho

KNIT TODAY
WOMEN'S GARMENT

Modern lacy vest

Worked in a circle from the centre front or back, this one-size vest makes for a very exciting knit!

By *Louisa Harding*

SKILL LEVEL



INTERMEDIATE

TECHNIQUES

◆ KNITTING IN THE ROUND

Pattern
info

“The loose, heavy drape, created by working on larger needles, makes this vest great for all shapes”



CHARLENE,
ART
EDITOR

Inspired by the vibrancy of festival colours and free wheeling spirit, this top, created in the round, has a loose, carefree drape and is made in Louisa Harding's incredibly soft new yarn – the ideal match for this fabulous summer make!

Materials

- ◆ Yarn
4 x 50g balls of Louise Harding Anise DK Yarn in Lovage (shade 504)
- ◆ Needles
A pair of 7mm (UK 2, US 10.75) double-pointed needles
A 7mm (UK 2, US 10.75) 60cm (23½in) circular knitting needle
A 7mm (UK 2, US 10.75) 120cm (47in) circular knitting needle
- ◆ Accessories
6 stitch markers

Yarn detail

- ◆ Louisa Harding Anise DK Yarn
www.designeryarns.uk.com
01535 664222
- ◆ DK weight

- ◆ 45% cotton, 45% acrylic, 10% polyamide
- ◆ 50g/70m (76yds)
- ◆ Hand wash
- ◆ £4.95

Tension

13 sts and 20 rows to 10cm or 4in measured over st st using 7mm knitting needles.

Finished size

Designed in one size.
Widest width point to point 58cm (23in).

Pattern notes

This garment is knitted in a circular shape starting at the centre of the back/front. It's created in one size and has been photographed on a model 5ft 11in tall, dress size UK 8.

Special abbreviations

- dpn** Double-pointed needle
- inc 2** (K1, yo, k1) into 1 stitch (3 stitches)
- SSK** Slip 2 sts knitwise one at a time from the LH needle to the RH needle, insert LH needle tip through both front loops and knit together
- SSM** Slip stitch marker

◆ Turn to page 92 for full list of abbreviations



Pattern from *Louisa Harding Spring Summer 2015 Book*, £5.95 www.designeryarns.uk.com

BACK

Using 7mm dpn and yarn A make a slip knot and place on a dpn. With second dpn, (k1, p1) 6 times into slip knot. 12 sts
Distribute sts evenly over 3 dpns, (4 sts on each dpn), place a marker, join work and cont in rounds as follows:

Round 1 and every alt round: Knit.

Round 2 (inc): (Yo, k1) 12 times. 24 sts

Round 4 (inc): (K2, inc 2, k1) 6 times. 36 sts

Round 6 (inc): (K3, inc 2, k2) 6 times. 48 sts

Round 8 (inc): (K4, inc 2, k3) 6 times. 60 sts

Round 10 (inc): (K5, inc 2, k4) 6 times. 72 sts

Round 11: Knit.

Change to a 60cm long 7mm circular needle and place stitch markers as follows:

Round 12 (inc): (K6, inc 2, k5, place a stitch marker) 6 times. 84 sts

Round 13: (K14, SSM) 6 times.

Round 14 (inc): (K7, inc 2, k6, SSM) 6 times. 96 sts

Round 15: (K16, SSM) 6 times.

Round 16 (inc): (K8, inc 2, k7, SSM) 6 times. 108 sts

Round 17: (K18, SSM) 6 times.

Round 18 (inc): (K9, inc 2, k8, SSM) 6 times. 120 sts

Round 19: (K20, SSM) 6 times.

Round 20: (K1, yo, SSK, k15, k2tog, yo, SSM) 6 times.

Round 21: (K20, SSM) 6 times.

Round 22 (inc): (([K1, yo] twice, SSK, k13, k2tog, yo, k1, yo, SSM) 6 times. 132 sts

Round 23: (K22, SSM) 6 times.

Round 24 (inc): (([K1, yo, k2tog, yo, k1, yo, SSK, k11, [k2tog, yo] twice, k1, yo, SSM) 6 times. 144 sts

Round 25: (K24, SSM) 6 times.

Round 26 (inc): (([K1, [yo, k2tog] twice, yo, K1, yo, SSK, k9, [k2tog, yo] 3 times, k1, yo, SSM) 6 times. 156 sts

Round 27: (K26, SSM) 6 times.

Round 28 (inc): (([K1, [yo, k2tog] 3 times, yo, k1, yo, SSK, k7, [k2tog, yo] 4 times, k1, yo, SSM) 6 times. 168 sts

Round 29: (K28, SSM) 6 times.

Round 30 (inc): (([K1, [yo, k2tog] 4 times, yo, k1, yo, SSK, k5, [k2tog, yo] 5 times, k1, yo, SSM) 6 times. 180 sts

Round 31: (K30, SSM) 6 times.

Change to a 120cm long 7mm circular needle.

Round 32 (inc): (([K1, [yo, k2tog] 5 times, yo, k1, yo, SSK, k3, [k2tog, yo] 6 times, k1, yo, SSM) 6 times. 192 sts

Round 33: (K32, SSM) 6 times.

Round 34 (inc): (([K1, [yo, k2tog] 6 times, yo, k1, yo, SSK, k1, [k2tog, yo] 7 times, k1, yo, SSM) 6 times. 204 sts

Round 35: (K34, SSM) 6 times.

PILTON VEST

Round 36 (inc): (([K1, [yo, k2tog] 7 times, yo, K1, yo, S11, k2tog, pssso, yo, [k2tog, yo] 7 times, k1, yo, SSM) 6 times. 216 sts

Round 37: (K36, SSM) 6 times.

Round 38 (inc): (([K1, yo, [k2tog, yo] 17 times, k1, yo, SSM) 6 times. 228 sts

Round 39: (K38, SSM) 6 times.

Round 40 (inc): (([K1, yo, k37, yo, SSM) 6 times. 240 sts

Round 41: (P40, SSM) 6 times.

Round 42 (inc): (([K1, yo, k39, yo, SSM) 6 times. 252 sts

Round 43: (P42, SSM) 6 times.

Round 44 (inc): (([K1, yo, k41, yo, SSM) 6 times. 264 sts

Turn work and cast off knitwise on WS, taking care not to pull stitches too tightly, removing all stitch markers.

FRONT

Work as for back.

MAKING UP

Sew in all ends, then press and block as described on the ball band. You will now have two hexagonal pieces. Using the photograph and size diagram construct the top as follows:

NECK OPENING

Lay flat the pieces RS together. Sew together the two pieces at the top of sides 1 to make shoulder seams, leaving 28cm (11in) open for neck.

LEFT SIDE SEAM

Using the size diagram illustration sew together 10cm (4in) from widest point upward of sides 2 to create the left side seam.

RIGHT SIDE SEAM

Using the size diagram illustration sew together 10cm (4in) from the widest point upward of sides 6 to create the right side seam. 



The rainbow of colours in this great top look perfect with blue denim

MAKING UP DIAGRAM

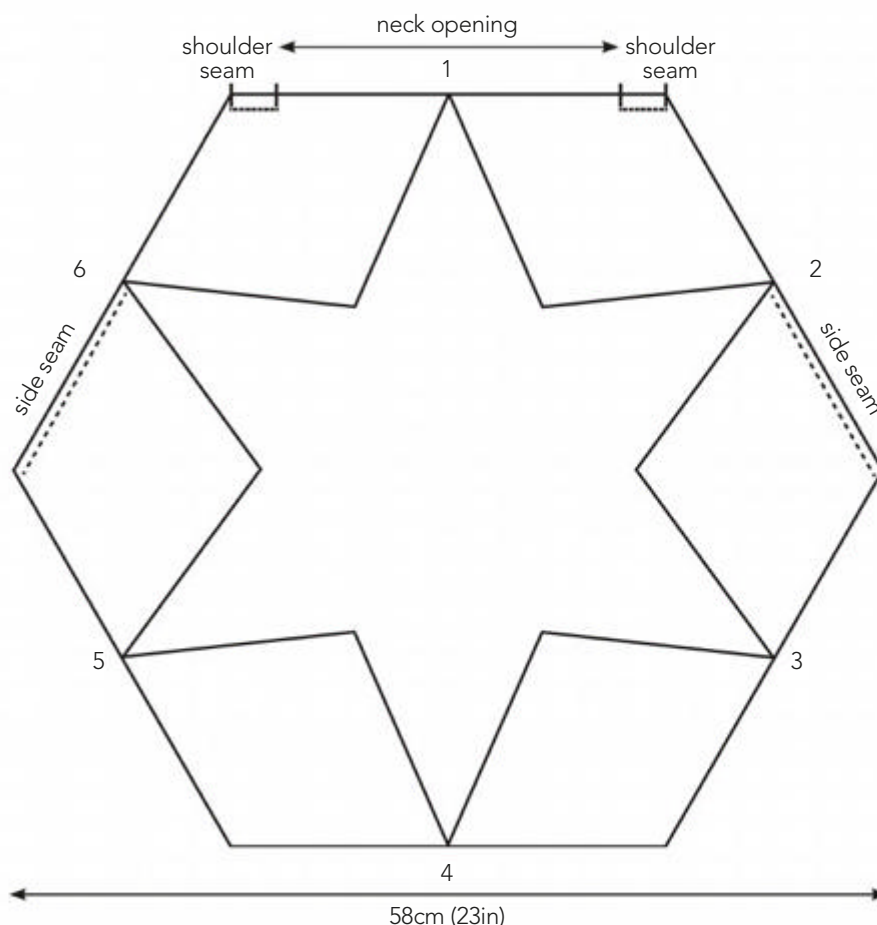

Purl
OF WISDOM

Because the drape of this top is so key to the final look, take extra care when blocking and making up this item. We're sure you'll be glad you did!

SKILL LEVEL



EASY

TECHNIQUES

- ◆ SHAPING
- ◆ MAKING UP

EXCLUSIVE
KNIT TODAY PATTERN

Ahoy there, cutie!

Baby sailor suits are adorable and they don't come much cuter than this classic knit. By **Sublime** for Knit Today



“Cute classics like this will never go out of style, and this sailor onesie works just as well for boys or girls”



ROSEE,
EDITOR

Keep baby comfy with this sweet knitted sailor suit and bootie set from Sublime. Worked in simple stitches, this makes a great unisex gift to knit for a new arrival that is within the

reach of all levels of knitter. The lovely silk and cotton blend yarn is soft to the touch and will feel silky next to baby's delicate new skin, but is machine washable at 40°C, which is sure to be appreciated by parents!

Materials

- ◆ Yarn
Little Sailor Suit
Yarn A: 3 (4:4) x 50g balls of Sublime Cotton Silk DK in Poplin (shade 443)
Yarn B: 1 (1:1) x 50g ball of Sublime Cotton Silk DK in Anglaise (shade 438)
Little Sailor Boots
Yarn A: 1 (1:1) x 50g ball of Sublime Cotton Silk DK in Poplin (shade 443)
Yarn B: 1 (1:1) x 50g ball of Sublime Cotton Silk DK in Anglaise (shade 438)
- ◆ Needles
1 pair of 4mm (UK 8, US 6)

1 pair of 3.25mm (UK 10, US 3)

- ◆ Accessories
1 stitch holder
5 Buttons for Sailor Suit

Yarn detail

- ◆ Sublime Cotton Silk DK
sublimeyarns.com
01924 231682
- ◆ Double knit weight
- ◆ 25% silk, 75% cotton
- ◆ 50g/125m (137yds)
- ◆ Machine wash at 40°C
- ◆ £5.30

Tension

22 stitches and 28 rows on 4mm needles in stocking stitch to 10cm or 4in on 4mm needles
22 stitches and 40 rows on 4mm needles in garter stitch to 10cm or 4in on 4mm needles

Finished size

The sailor boots have been designed to fit an average-sized baby's foot for the age indicated

Special abbreviations

S1p slip 1 stitch purlways – insert the right hand needle into next stitch as if to purl but just slip it off the left hand needle onto the right hand needle without working.

◆ Turn to page 92 for full list of abbreviations

LITTLE SAILOR SUIT

BACK

1ST LEG

Using 3.25mm needles and B, cast on 21 (24:25) sts.

Row 1 (RS): Knit.

1st row forms garter stitch.

Work 1 row in garter stitch.

Change to A and work 2 rows in garter stitch.

Change to B and work 4 rows in garter stitch.

Change to 4mm needles and A. **

Row 1 (RS): Increase in 1st st, knit to end. 22 (25:26) sts

Row 2 (WS): Purl.

Beginning with a knit row work in stocking stitch for the remainder of the 1st leg as follows:

Work 2 (2:0) rows without shaping.

Repeat 1st and 2nd rows 2 (2:3) times.

24 (27:29) sts

Next row: Increase in 1st st, knit to end.

25 (28:30) sts

Next row: Purl to last 2 sts, increase in next st purlways, p1.

26 (29:31) sts

Repeat last 2 rows once.

28 (31:33) sts

Break off yarn and leave these 28 (31:33) sts on a stitch holder.

2ND LEG

Work as given for 1st Leg of Back to **.

Row 1 (RS): Knit to last 2 sts, increase in next st, k1. 22 (25:26) sts

Row 2 (WS): Purl.

Beginning with a knit row work in stocking stitch for the remainder of the 2nd leg as follows:

Work 2 (2:0) rows without shaping.

Repeat 1st and 2nd rows 2 (2:3) times more.

24 (27:29) sts

Next row: Knit to last 2 sts, increase in next st, k1.

25 (28:30) sts

Next row: Increase in 1st st purlways, purl to end. 26 (29:31) sts

Repeat last 2 rows once.

28 (31:33) sts

Next row: Knit to end, cast on 4 (4:6) sts, with right side of the work facing you, knit across 28 (31:33) sts left on a stitch holder for 1st leg.

60 (66:72) sts

Place a marker thread at centre of 4 (4:6) cast on sts.

Continue in stocking stitch for the remainder of the back as follows:

Work without shaping until back measures

SIZING GUIDE		0 - 6 MONTHS	6 - 12 MONTHS	1 - 2 YEARS
TO FIT CHEST	cm	41	46	51
	in	16	18	20
ACTUAL CHEST	cm	45	51	56
	in	17¾	20	22
FULL LENGTH (APPROX)	cm	41	46	51
	in	16	18	20
SLEEVE LENGTH	cm	3	3	3
	in	1¼	1¼	1¼

10 (11:13) cm or 4 (4¼:5¼) in from marker thread, finishing after a purl row.

SHAPE SIDES

Work 25 (12:24) rows, dec 1 st at each end of next and every foll 6th (6th:8th) row.
50 (62:66) sts

For 2nd and 3rd sizes only

Work (17:11) rows dec 1 st at each end of next and every foll (8th:10th) row. (56:62) sts

For all 3 sizes

Work without further shaping until back measures 21 (24:28) cm or 8¼ (9½:11) in from marker thread, finishing after a purl row. The back should measure approximately 23 (25:28) cm or 9 (9¾:11) in across at this point.

SHAPE SLEEVES

Work 5 rows increasing 1 st at each end of every row. Place a marker thread at each end of last row.

60 (66:72) sts ***

Work without further shaping until sleeves measure 12 (14:15) cm or 4¾ (5½:6) in from marker thread, finishing after a purl row.

SHAPE UPPER SLEEVES AND SHOULDERS

Cast off 14 (15:16) sts at beginning of next 2 rows. 32 (36:40) sts

Cast off 9 (10:11) sts at beginning of next 2 rows. 14 (16:18) sts

Cast off remaining 14 (16:18) sts.

FRONT

Work as given for Back to ***.

Next row: Purl.

SHAPE NECK

Next row: K28 (31:34), k2tog, turn, slip remaining 30 (33:36) sts onto a stitch holder. You will come back to these 30 (33:36) sts later to work the second side of the neck.
29 (32:35) sts

Work 3 rows without shaping.

Work 21 (16:24) rows decreasing 1 st at neck edge in 1st and every following 4th row.

23 (28:29) sts

For 2nd and 3rd sizes only

Work (13:7) rows decreasing 1 st at neck edge in 1st and every following 6th row. You will now have (25:27) sts on the needle.

For all 3 sizes

Work without further shaping until sleeves measure same as Back to upper sleeves and



Garner stitch detailing in a contrasting colour gives this sailor his stripes!



The deep collar is knitted separately and then attached at the neck



The stitches and styling of the booties reflect those in the sailor suit

shoulders, finishing after a purl row.

SHAPE UPPER SLEEVES AND SHOULDERS

Next row: Cast off 14 (15:16) sts, knit to end. 9 (10:11) sts

Next row: Purl.

Cast off remaining 9 (10:11) sts.

Return the 30 (33:36) sts left on a stitch holder onto the main needles.

With right side of the work facing you, rejoin yarn and k2tog, knit to end. 29 (32:35) sts

Work 3 rows without shaping.

Work 21 (16:24) rows decreasing 1 st at neck edge in 1st and every following 4th row. 23 (28:29) sts

For 2nd and 3rd sizes only

Work (13:7) rows decreasing 1 st at neck edge in 1st and every following 6th row. (25:27) sts

For all 3 sizes

Work without further shaping until sleeves measure same as Back to upper sleeves and shoulders, finishing after a knit row.

SHAPE UPPER SLEEVES AND SHOULDERS

Next row: Cast off 14 (15:16) sts, purl to end. 9 (10:11) sts

Next row: Knit.

Cast off remaining 9 (10:11) sts.

SLEEVE BORDERS (BOTH ALIKE)

Join upper sleeves and shoulder seams.

With right side of the work facing you, using your smaller needles and B, pick up and knit 46 (56:60) sts evenly between markers.

Work 3 rows in garter stitch.

Change to A and work 2 rows in garter stitch.

Change to B and work 3 rows in garter stitch.

Cast off knitways.

CROTCH

BACK

With right side of the work facing you, using 3.25mm needles and B, pick up and knit 16 sts evenly along right side of crotch, 3 (3:5) sts from 4 (4:6) cast on sts and 16 sts evenly along left side of crotch.

35 (35:37) sts

Work 3 rows in garter stitch.

Change to A and work 2 rows in garter stitch.

Change to B and work 3 rows in garter stitch.

Cast off knitways.

FRONT

With right side of the work facing you, using 3.25mm needles and B, pick up and knit 16 sts evenly along right side of crotch, 3 (3:5) sts from 4 (4:6) cast on sts and 16 sts evenly along left side of crotch.

35 (35:37) sts on the needle.

Work 3 rows in garter stitch.

Next row: Change to A, k3 (3:2), cast off 1 st, [k5 (5:6), cast off 1 st] 4 times, k2 (2:1).

Next row: K3 (3:2), cast on 1 st, [k6 (6:7), cast on 1 st] 4 times, k3 (3:2).

Change to B and work 3 rows in garter stitch.

Cast off knitways.

COLLAR

Using 3.25mm needles and B, cast on 36 (38:44) sts.

Row 1 (RS): Knit.

This forms garter stitch.

Work 1 row in garter stitch.

Change to A and work 2 rows in garter stitch.

Change to B and work 4 rows in garter

stitch.

Change to 4mm needles and A.

Beginning with a knit row work in stocking stitch for the remainder of the collar as follows:

Continue until collar measures 12 (14:15) cm or 4¾ (5½:6) in, finishing after a purl row.

Next row: K11 (11:13), slip the remaining 25 (27:31) sts onto a stitch holder, you will come back to these 25 (27:31) sts later to work the second side of the collar.

11 (11:13) sts

Continue until collar measures 6 (7:7) cm or 2½ (2¾:2¾) in from stitch holder, finishing after a purl row.

Work 12 (12:18) rows decreasing 1 st at beginning of 1st and following 6th row.

9 (9:10) sts

Work 8 (8:12) rows, decreasing 1 st at beginning of 1st and every following 4th row. 7 sts

Work 4 rows, decreasing 1 st at beginning of 1st and following 2nd row. 5 sts

Place a marker thread at beginning of last row.

Work 10 (12:14) rows without shaping.

Next row: K2, k2tog, k1. 4 sts

Next row: P1, p2tog, p1. 3 sts

Next row: K3tog. Fasten off.

To work the second side of the collar return the 25 (27:31) sts left on a stitch holder onto the main needles. With right side of the work facing you, rejoin yarn to the remaining 25 (27:31) sts and cast off 14 (16:18) sts loosely, k10 (10:12).

11 (11:13) sts

Continue until collar measures 6 (7:7) cm or 2½ (2¾:2¾) in from cast off sts, finishing after a purl row.

Work 12 (12:18) rows decreasing 1 st at end of 1st and every following 6th row.

9 (9:10) sts

Work 8 (8:12) rows decreasing 1 st at end of 1st and every following 4th row. 7 sts

Work 4 rows decreasing 1 st at beginning of 1st and following 2nd row. 5 sts

Place a marker thread at end of last row.

Work 10 (12:14) rows without shaping.

Next row: K1, k2tog, k2. 4 sts

Next row: P1, p2tog, p1. 3 sts

Next row: K3tog. Fasten off.

COLLAR EDGING

1ST SIDE

With right side of the work facing you, using 3.25mm needles and B, pick up and knit 5 sts evenly along border and 67 (74:81) sts evenly along side edge of collar.

72 (79:86) sts

Work 1 row in garter stitch.

Next row: Knit to last 2 sts, k2tog.

71 (78:85) sts

Next row: K2tog, knit to end.

70 (77:84) sts

Next row: Change to A, knit to last 9 (10:12) sts, change to B, k7 (8:10), k2tog.

69 (76:83) sts

Next row: K2tog, k7 (8:10), change to A, knit to end.

68 (75:82) sts

Next row: Change to B, knit to last 2 sts, k2tog.

67 (74:81) sts

Next row: K2tog, knit to end.

66 (73:80) sts

Next row: Knit to last 2 sts, k2tog.

65 (72:79) sts

Cast off knitways.

2ND SIDE

With right side of the work facing you, using 3.25mm needles and B, pick up and knit 67 (74:81) sts evenly along side edge of collar and 5 sts evenly along border.

72 (79:86) sts

Work 1 row in garter stitch.

Next row: K2tog, knit to end.

71 (78:85) sts

Next row: Knit to last 2 sts, k2tog.

70 (77:84) sts

Next row: K2tog, k7 (8:10), change to A, knit to end.

69 (76:83) sts

Next row: Knit to last 9 (10:12) sts, change to B, k7 (8:10), k2tog.

68 (75:82) sts

Next row: K2tog, knit to end.

67 (74:81) sts

Next row: Knit to last 2 sts, k2tog.

66 (73:80) sts

Next row: K2tog, knit to end.

65 (72:79) sts

Cast off knitways.

LOOP

Using 3.25mm needles and A, cast on 13 (15:17) sts and knit 2 rows.

Cast off knitways.

MAKING UP

Join side and sleeve seams.

Sew on buttons to back crotch corresponding with buttonholes on front.

With wrong side of collar to right side of work, sew collar evenly in position all round neck edge to marker, leaving remainder of collar free for ties.

Fold loop in half and sew seam, attach loop to centre front of neck. Pin out garment to the measurement given and cover with

damp cloths until dry.

See ball band for washing and further care instructions.

LITTLE SAILOR BOOTS

Using 3.25mm needles and B, cast on 23 (27:31) sts.

Row 1 (RS): Knit.

Row forms garter stitch.

Row 2 (WS): K1, m1, k10 (12:14), m1, k1, m1, k10 (12:14), m1, k1.

27 (31:35) sts

Row 3: Knit.

Row 4: K1, m1, k11 (13:15), m1, k3, m1, k11 (13:15), m1, k1.

31 (35:39) sts

Row 5: Knit.

Row 6: K1, m1, k12 (14:16), m1, k5, m1, k12 (14:16), m1, k1.

35 (39:43) sts

Row 7: Knit.

Row 8: K1, m1, k13 (15:17), m1, k7, m1, k13 (15:17), m1, k1.

39 (43:47) sts

Change to 4mm needles and A.

Beginning with a knit row work 10 rows in stocking stitch.

SHAPE INSTEP

Row 1 (RS): K23 (26:29), s1, k1, pssso, turn.

Row 2 (WS): S1p, p7 (9:11), p2tog, turn.

Row 3: S1, k7 (9:11), s1, k1, pssso, turn.

Rep 2nd and 3rd rows 3 (4:5) times.

Next row: S1p, p7 (9:11), p2tog, turn.

29 (31:33) sts

Next row: S1, knit to end.

Next row: Purl to end decreasing 4 sts evenly across row.

25 (27:29) sts

Change to 3.25mm needles and B.

Work in garter stitch for 3cm or 1¼in from decrease row, finishing after a right side row.

Next row: K2 (3:4), m1, (k7, m1) 3 times, k2 (3:4).

29 (31:33) sts

Continue in garter stitch for 6cm or 2½in from decrease row, finishing after a right side row.

Change to A and work 2 rows in garter stitch.

Change to B and work 3 rows in garter stitch.

Cast off knitways.

TO MAKE UP

Join foot and back seam reversing sewing for turnback.

See ball band for washing and care instructions. 



RITA TAYLOR

"Neat, secure herringbone stitch and puffed bowknot stitch make a practical and attractive combination for a summer bag"

SKILL LEVEL



INTERMEDIATE

TECHNIQUES

- ◆ HERRINGBONE
- ◆ BOWKNOT STITCH

EXCLUSIVE
KNIT TODAY PATTERN

Beautiful bowknot bag

Knitted bags are perfect for summer and few are more lovely than this one!
by *Rita Taylor*

Pattern
info

"Bowknot stitch is much easier than you think and creates a lovely 'puffed-up' finish that's ideal for bags"



SOPHIE,
OPERATIONS
EDITOR

Created using a delightful mix of herringbone and bowknot stitch, this bag is a pure joy to make for those eager to learn a new technique. We love the strong softness provided by King Cole's Comfort Aran which helps to keep the pretty bell shape and gives a sturdy finish. Whip it up in pretty Hyacinth (shade 1504) and you'll be ready for sauntering around car boot sales and antiques markets.

Materials

- ◆ Yarn
2 x 100g balls of King Cole Comfort Aran in Hyacinth (shade 1504)
- ◆ Needles
1 pair of 4mm (UK 8, US 6)

- 1 pair of 4.5mm (UK 7, US 7) knitting needles
- A 5mm (UK 6, US 8) circular needle, 60cm long
- ◆ Accessories
35cm (13¾in) narrow elastic

Yarn detail

- ◆ King Cole Comfort Aran
www.kingcole.co.uk
01756 703670
- ◆ 60% supersoft acrylic, 40% supersoft nylon
- ◆ 100g/202m (220 yards)
- ◆ Machine wash at 40°C
- ◆ £3.79

Tension

18 sts and 24 rows to 10cm using 5mm needles over bowknot stitch

Finished size

60cm or 24in diameter
28cm or 11in depth

Special abbreviations

K1b knit 1 below:
insert your needle into the stitch hole directly below the stitch you would normally work

- ◆ Turn to page 92 for full list of abbreviations

Yarn alternatives

- ◆ Patons Baby Fab Aran
www.makeitcoats.com
01484 681881
- ◆ Debbie Bliss Blue Faced Leicester Aran www.designeryarns.uk.com
01535 664222

HERRINGBONE STITCH, WORKED FLAT

Row 1 (WS): *P2tog, leaving sts on left needle; purl first stitch again, and take both sts from left needle; repeat from * to last st, p1.

Row 2: *Slip next stitch purlwise, K1; insert left needle through slipped st and knit it, take both sts from left needle * repeat from * to last st, k1.

TINY BOWKNOT WORKED IN THE ROUND

Round 1: Knit

Round 2: Knit

Round 3: *K3, p3; rep from *

Round 4: *K3, p1, k1b, p1; rep from *

Round 5: Knit

Round 6: Knit

Round 7: *P3, k3; rep from *

Round 8: P1, k1b, p1, k3; rep from *

Using 4.5mm needles, cast on 15 sts.

Knit 1 row then work 23 rows in herringbone stitch. Change to circular 5mm needle. K15, pick up and knit 25 along side, k15 from cast on edge, pick up and knit 25 along other side. 80 sts

Next round: Knit, increasing in every 2nd stitch. 120 sts

Knit 1 round then work tiny bowknot stitch to 22cm.

Change to 4.5mm needles

Row 1: Knit 59, inc in next st, turn.

Work herringbone stitch for 9 rows.

Change to 4mm needles and work 2 rows of K1, P1 rib. Cast off.

Return to rem sts and work 2nd side to match.

HANDLE

Using 4.5mm needles, cast on 15 sts and work in herringbone stitch to approx 44cm (17½in). Cast off. Join side edges of top band. Sew handle to top edge above side seams. Thread narrow elastic through last row of rib.

Darn in all ends. 



Bowknot stitch is worked by knitting the stitch below the one on the needle



When you need a thick stitch for your bag, Herringbone's the one!





SARAH HEYS
A talented young designer who loves to create modern homeware using super-chunky yarn



JOANNA BENNER
Jo is our technical editor – no knitting niggles or crochet conundrums is too tricky for her



ANEETA PATEL
Jo is a professional knitting teacher, successful author and has been knitting since she was 5!

Sponsored by Artesano Yarns
artesanoyarns.co.uk



ask THE EXPERTS

Whatever your knitting or crochet query, our experts can give you a helping hand!

BLAME IT ON THE MOTHS

Q I'm working a square of knitting using intarsia, but it looks like I forgot to twist the yarns at one point and there's a hole in my knitting. It took me ages to get this far on a new technique and I'm so disappointed in myself for the mistake.

Rachel Woodham, Manchester

A Aneeta says: Don't be so hard on yourself, Rachel. There's no need to unravel your knitting. You can still affect a neat, quick fix on this by sewing up the hole from the wrong side of your work. Use the loose tails of yarn as you are weaving them in if there is one near your hole, or use some regular sewing thread in a matching colour for a subtle repair. Nobody will ever know!



A few little stitches will repair this broken heart

FIT FOR PURPOSE

Q I'd really like to knit myself a small bag but I can't think what yarn to use as I want it to last – do you have any yarn suggestions?

Tina Edwards, Newport

A Sarah says: I think t-shirt yarn is perfect for knitting bags with; it is hardwearing and will survive being used often. It is also



T-shirt yarn lets you knit structured bags like this from Wool and the Gang

more structured than other yarns so you could knit different styles and designs of bag rather than the typical knitted totes you see everywhere. Wool and the Gang have some great knitted bag kits like this Hey Now Clutch (£37.50 for the kit) that comes with the yarn, instructions and a bag strap you need to make it. I hope that helps!

TWISTING AROUND

Q I'm teaching myself to knit in the round but it's not going very well. I managed to cast on, but I've just worked my first round and it looks like the knitting has twisted! Do I need to undo my knitting and start again?

Angela Bradley, Middlesex

A Aneeta says: Stop! You can fix this at this stage without having to undo your knitting. If you've worked one or two rounds only and it looks like the work has twisted, you can untwist your knitting by rearranging the

needles at the point where they meet the next needle. You can only correct this in the first couple of rounds, which is why it's so important to check every time you get to the marker at the start of the round. After this point, you will need to undo as the twist will be too prominent to fix.

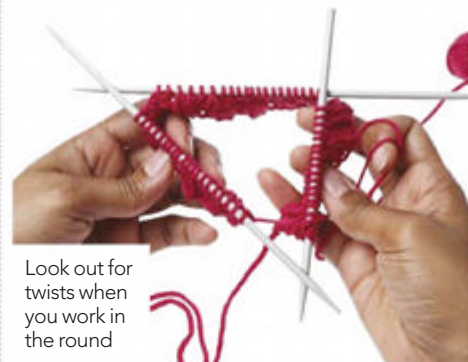

Look out for twists when you work in the round

BEGINNERS START HERE

Q I am a complete beginner but want to try and learn to knit. I have tried to buy some knitting needles but I wasn't sure what all the different types are for, help!

Holly Davis, Kent

A Sarah says: When you first start knitting it can seem like there are lots of different needles available. First of all there are the different materials – metal, bamboo, wooden and plastic. Being a beginner I would recommend you use metal needles as these are often the cheapest and the stitches will slip off easily. Secondly there are the different sizes. If you have bought your yarn it will say on the ball band what size needle (in mm) you need. The sizes range from 2mm up to 25mm

and depend on the thickness of your yarn. It would be best to start off using a yarn that needs needles that are about 5/6mm because this will be less tricky to knit with while you are learning.



TEN TINY TOES

Q I would like to knit a baby blanket but I don't know where to start. Can you make any suggestions? Are squares the easiest option for me, or is it possible to knit the blanket in one piece?

Julia McKennah, Aberdeen



A Aneeta says: I'd avoid a blanket that comes in squares. The squares may be easy, but you'll spend an awfully long time sewing them up and it's tricky to get a neat finish with so many seams.

I suggest you knit your blanket in one piece using a

long circular needle, but knitting in straight rows. Although each row is long, once you are finished you won't have to face hours of extra sewing. Knitting in this way you get an idea of the finished blanket as you go and can make a decision on the length more easily.

CROCHET FIRST TIMER

Q I'm new to crochet and would like to make something for my home. I tend to like modern designs. Would you be able to recommend a pattern book?

Sharon Harris, Liverpool

A Sarah says: I've found this book Modern Crochet (from good bookshops £20) which I think you would like. It explains with step-by-steps how to crochet household items from lampshades to rugs. The designs are modern and use



Crochet homewares have had a modern-day makeover!

bright yarns so I think it would suit your style!

THE SUMMER OF KNITTING

most talked about

Wool less appealing as temperatures rise? Joanna Benner's got the answer for cool knits

HOLIDAY KNITWEAR

Q I've got time for just one pre-holiday knit. What shall I make?

Chloe Wilde, Cumbria

A Jo says: Without doubt, a wrap is the most important. Wear it on cool evenings or put it on when you board the plane – it won't take up room in your luggage. You can then use it as a blanket on the plane. I have a very old cashmere pashmina that (almost!) needs replacing and I'm going to go for this pattern (8861/£2.99) from Stylecraft. It uses four balls of Stylecraft Senses (£3.29/50g) lace weight yarn and is knitted on 4mm needles – so it's not too fiddly! For stockist go to www.stylecraft-yarns.co.uk or call 01535 609798.



Choose a lace yarn for lightness and warmth

COTTON YARN

Q I'd like to knit my girl a double knit cotton cardi for the summer but the last time I made one I had trouble getting her arms in as it was so stiff,

Lily Stokes, Chepstow

A Jo says: There are a lot of cotton yarns that are a mixture of cotton and another fibre, which makes the yarn much more pliable and easy to wear for summer – combining the look of cotton with the warmth of the added yarn.

For adults it's worth paying out for a luxury yarn like Sublime Cotton Silk DK, which is £5.49 for a 50g ball. It's a joy to



Go for a blend to keep cotton comfortable

knit and wear. As little ones grow out of their clothes quickly I would suggest using a cotton/acrylic yarn from James C Brett (for stockists go to www.jamescbrett.co.uk), which can withstand the wear and washing that children's clothes require. Cotton On DK is £1.99 for 50g and, with 26 shades to choose from (including 10 multi shades), there's bound to be one that you both like.

which means knitting is as quick with them as it would be with metal needles. They're also much lighter than metal needles, which is a plus for people with fibromyalgia or arthritis.



KnitPro Symfonie needles are pretty as well as practical

DITCH THE METAL!

Q I like knitting all year round but my sweaty hands in the summer make my needles squeak!

Sharon Grieves, Harrow

A Jo says: I would suggest you swap the metal needles for bamboo or wood. Both are absorbent so it's worth cleaning the needles regularly and washing your finished knit. KnitPro Symfonie Wood 25cm Straight Needles are £5.30 a pair from www.woolstack.co.uk, available in sizes 3mm to 6mm. They're laminated so the yarn doesn't drag on the needles,

3 tips for summer knitting

- Always choose a project with a loose gauge.
- Keep wipes and talcum powder handy to clean your hands regularly.
- Choose small, light projects – leave that blanket until the nights start to get chilly!

win
OVER £600
WORTH OF
PRIZES!



Playful prints

Knitting for kids is a pleasure with Debbie Bliss Rialto DK Print. A beautiful, superfine merino, Rialto DK Print is super soft on the skin and washable too, making it ideal for the littlies in your life. The self-stripping colourways also mean you can get a fab colourful effect, without lots of ends to sew in when your garment is finished! We have three sets of Rialto DK Print yarns in Florance, Pisa and Ravenna plus a Rialto DK Print pattern book featuring 12 fantastic kids knits to giveaway to three lucky readers. For more info go to www.designeryarns.uk.com

♦ **How to enter.** Simply search for our missing sheep – he's hiding somewhere in this issue. Send us a postcard telling us which page he is on, plus your name, address, email address and telephone number to: Rialto giveaway 114, *Knit Today*, 2nd Floor, Tower House, Fairfax Street, Bristol BS1 3BN.

Reader giveaways

We have some gorgeous goodies for you to win this month – so enter today!

Can you find our lost sheep?



Baa-rillicant kits!

Who can resist the super cute and very lovable herdy lamb rucksack and huggable herdy sheep cushion cover? Not us! Here's your chance to win both of these adorable kits plus three sets of trendy stitch markers when you enter our giveaway today. Each kit includes all the lovely UK-produced herdywool you need to create your rucksack and cushion cover along with full instructions, and both are ideal for intermediate knitters and confident beginners who fancy a challenge. For more info visit www.herdy.co.uk.

♦ **How to enter.** Enter online at www.knit-today.com or text KT114HERDY and your name, followed by a space to 87474. Or send a postcard to Herdy giveaway 114, *Knit Today*, 2nd Floor, Tower House, Fairfax Street, Bristol BS1 3BN. Please include your name, address, email address and telephone number.



All heart

Here at *Knit Today* we heart Red Heart's fantastic range of yarns. With their on-trend colours and gorgeous textures they really do have a yarn for every occasion! Our lovely friends at Red Heart have put together an irresistible prize bundle featuring a selection of their favourite yarns including the elegant Precious, Detroit, Reflective, Soft, Baby Prints and Sports Socks. We have 10 sets of yarn to giveaway, worth £15 each so be sure to get your entries in today! For more info visit www.redheart.co.uk

♦ **How to enter.** Enter online at www.knit-today.com or text KT114HEART and your name followed by a space to 87474. Or send a postcard to Heart giveaway 114, *Knit Today*, 2nd Floor, Tower House, Fairfax Street, Bristol BS1 3BN. Please include your name, address, email address and telephone number.



In fashion

Rico Design's Fashion Fantasy 100% cotton DK is one of our favourite yarns this summer, for its soft, lightweight finish and beautiful drape. The five multicoloured shades create a subtle tonal effect once knitted up and the ideal layer to throw on after a day at the beach. We have five prizes of 10 balls of Fashion Fantasy DK to giveaway; each prize includes a mix of Blue Mix (shade 005) and Purple Mix (shade 003) so get your entries in today! For more info go to www.rico-design.de

♦ **How to enter.** Enter online at www.knit-today.com or text KT114FASHION and your name followed by a space to 87474. Or send a postcard to Fashion giveaway 114, *Knit Today*, 2nd Floor, Tower House, Fairfax Street, Bristol BS1 3BN. Please include your name, address, email address and telephone number.

TERMS & CONDITIONS Prizes will be dispatched within 28 days of judging. There are no cash alternatives. Employees of Immediate Media and contributing companies are not allowed to enter. A list of winners' names is available on request. The judges' decision is final. By entering this competition you are agreeing to receive details of future offers and promotions from Immediate Media Company and related third parties. If you do not want to receive this, please add the words 'NO INFO' at the end of your text message or write 'NO INFO' on your postcard. UK and Channel Islands entrants only. *Texts will be charged at 50p plus your standard network tariff rate. The closing date for competitions is 21 July 2015, unless otherwise stated.

SKILL LEVEL



INTERMEDIATE

TECHNIQUES

- ◆ EYELET CABLING
- ◆ SHAPING

KNIT TODAY
MEN'S GARMENT

Cappuccino casual

Wrap him up in this understated stocking stitch knit with lace detail for effortless sophistication.

By *Bergère de France*



- ◆ 48% recycled cotton, 48% recycled acrylic, 4% other recycled fibres
- ◆ 50g/130m (142yds)
- ◆ Machine wash at 30°C
- ◆ £3.35

Tension

22 sts and 30 rows over st st using 3.5mm needles to make a 10cm or 4in square

Special abbreviations

Pattern *P3, pass the first of the three stitches just worked over the next two worked and off the needle; rep from * to end.

Row 1 (RS): * K2, p2, rep from * to last 2 sts, k2.

Row 2: * P2, k2, rep from * to last 2 sts, p2. These 2 rows form 2 x 2 rib.

Cont in rib as set until work measures 6cm or 2½in or 24 rows, increasing 2 sts on the final rib row for size XL only.

102 (110:118:128:138) sts

Change to 3.5mm needles and cont as follows:

22.5 (23.5:23.5:23:24) cm or 9 (9¼:9¼:9:9½) in or 66 (70:70:68:72) rows in st st.

4 rows in g st.

7 (7:8:8.5:8.5) cm or 2¾ (2¾:3¼:3½:3½) in or 22 (22:24:26:26) rows in st st.

4 rows in g st.

Then cont in st st until work measures 41 (42:43:43:44) cm or 16¼ (16½:17:17:17¼) in or 130 (134:136:136:140) rows total.

RAGLAN

Cast off 3 (3:3:3:6) sts at beg of next two rows. 96 (104:112:122:126) sts

Work 2 (2:0:0:0) rows straight.

Next row (RS dec): K2, k2tog, work to last 4 sts, skpo, k2.

Rep the dec row on every foll 4th (4th:2nd:2nd:2nd) row 3 (1:33:37:38) more times, then on every foll alt row 24 (29:0:0:0) times.

AND AT THE SAME TIME, when work measures 3.5 (3.5:4.5:5:5) cm or 1½ (1½:1¾:2:2) in or 12 (12:14:16:16) rows from the start of the raglan shaping, patt as follows:

4 rows g st.

18 (18:20:22:22) rows pattern st.

4 rows g st.

Work the remainder in st st.

Work the WS of pattern stitch as follows:

p3, work in pattern stitch until there are 3 sts rem on the LH needle, p3.

After the final raglan dec, work 1 row on the rem 40 (42:44:46:48) sts and cast off all the sts for the neck.

FRONT

Work the same as for Back until work measures 41 (42:43:43:44) cm or 16¼ (16½:17:17:17¼) in or 130 (134:136:136:140) rows total.

RAGLAN

Cast off 3 (3:3:3:6) sts at beg of next two rows.

96 (104:112:122:126) sts

Work 2 (2:2:0:0) rows straight.

Next row (RS dec): K2, k2tog, work to last 4 sts, skpo, k2.

Rep the dec row on every foll 4th

(4th:2nd:2nd:2nd) row 3 (1:29:33:34) more

“This colour goes with everything, but there are ten other shades to choose from!”

Materials

- ◆ Yarn
9 (10:11:12:12) x 50g balls of Ecoton in Jute (shade 289.201)
- ◆ Needles
1 pair 3mm (UK 11, US 2/3) needles
1 pair 3.5mm (UK 10/9, US 4) needles

Yarn detail

- ◆ Bergère Ecoton
www.bergèrededefrance.co.uk
- ◆ DK weight

- ◆ Turn to page 92 for full list of abbreviations



From Bergère de France magazine 178. Visit www.bergèrededefrance.co.uk



BENEDICT, DESIGNER

SIZING GUIDE		S	M	L	XL	XXL
TO FIT CHEST	cm	81 - 86	87 - 94	95 - 102	103 - 110	111 - 120
	in	34 - 32	34 - 37	37½ - 40	40½ - 43	43½ - 47
FINISHED CHEST	cm	90	98	106	114	124
	in	35½	38½	41½	45	48¾
LENGTH TO BACK NECK	cm	64	66	68	70	72
	in	25¼	26	26¾	27½	28¼
SLEEVE LENGTH	cm	50	50	50	50	50
	in	19½	19½	19½	19½	19½

STITCHES USED

PATTERN STITCH

Using 3.5mm needles. Over 2 sts.

Row 1 (RS): K1, * yo, k2 *, rep from * to *, ending with yo, k1.

Row 2: Work in pattern stitch.

Rep these 2 rows. When decreasing, the pattern stitch will be irregular.

BACK

Using 3mm needles cast on 102 (110:118:126:138) sts.

times, then on every foll alt row
20 (25:0:0) times.

AND AT THE SAME TIME, when work
measures 3.5 (3.5:4.5:5.5) cm or 1½
(1½:1¾:2:2) in or 12 (12:14:16:16) rows from
the start of the raglan shaping, patt as folls:

4 rows g st.

18 (18:20:22:22) rows pattern st.

4 rows g st.

Work the remainder in st st.

NECK

AND AT THE SAME TIME, when
work measures 58 (60:62:64:66) cm
or 23 (23½:24½:25¼:26) in or 178
(184:190:196:202) rows total, cast off the
central 16 (18:20:22:24) sts, then cont to
work each side of neck separately, keeping
raglan shaping correct and decreasing at
neck edge as folls:

4 sts once, 3 sts twice, 2 sts once.

Cast off the rem 4 sts.

With WS of work facing rejoin yarn to rem
sts and work other side of neck in the same
way, reversing neck and raglan shapings.

LEFT SLEEVE

Using 3mm needles cast on 50 (54:54:58:58) sts.

Work 6cm or 2½in or 24 rows in 2 x 2 rib,
increasing 2 sts on the final rib row for sizes
S, L & XXL. 52 (54:56:58:60) sts

Change to 3.5mm needles and starting
with a knit row cont in st st as folls:

Work 12 (10:10:8:8) rows.

Next row (inc): K2, inc 1, k to last 2 sts, inc
1, k2.

Rep inc row on every foll 12th
(10th:10th:8th:8th) row 9 (11:5:11:2) times,
then on every foll 0 (0:8th:6th:6th) row
0 (0:8:5:17) times.

AND AT THE SAME TIME, when work
measures 37.5 (37.5:36.5:36:36) cm
or 14¾ (14¾:14½:14¼:14¼) in or 118
(118:116:114:114) rows total work as folls:

4 rows g st.
7 (7:8:8:8.5) cm or 2¾ (2¾:3¼:3½:3½) in or
22 (22:24:26:26) in st st.

4 rows in g st.

Cont in st st.

After the final increase cont on the
72 (78:84:92:100) sts obtained until work
measures 50cm or 19¾in or
158 rows total.

RAGLAN

Cast off 3 (3:3:3:6) sts at beg of next two
rows.

Work 2 (2:0:0:0) rows straight.

Next row (RS dec): K2, k2tog, work to last 4
sts, skpo, k2.



This stocking and garter
stitch knit is brought to
life with a lacy stitch panel

Rep the dec row on every foll 4th
(4th:2nd:2nd:2nd) row 3 (1:29:33:34) more
times, then on every foll alt row
20 (25:0:0) times.

Cont to dec at the beg of every foll RS row
for raglan and at the beg of every foll WS
row cast off for neck as folls:

4 sts once, 3 sts once, 2 sts once, 1 st once.
Cast off rem 4 sts.

At the same time, when work measures
3.5 (3.5:4.5:5.5) cm or 1½ (1½:1¾:2:2) in or
12 (12:14:16:16) rows from the start of the
raglan shaping, patt as folls:

4 rows g st.

18 (18:20:22:22) rows pattern st.

4 rows g st.

Work the remainder in st st.

RIGHT SLEEVE

Work as for Left Sleeve reversing the raglan
and neck shaping.

NECKBAND

Using 3mm needles cast on
106 (110:114:118:122) sts.

Work 10 rows in 2 x 2 rib, leave the sts on a
spare needle.

TO MAKE UP

Join the raglan seams.

Graft the neckband around the neck.

Join the small neckband seam.

Stitch the side and sleeve seams.

Secure and weave in all ends. 

DESIGNER PROFILE



Hazel's gorgeous Fair Isle jumper is a triple trophy-winning make!



Introducing

Hazel Tindall

Discover one woman's mission to bring the beauty of Fair Isle knitting to the whole world...

Living in quiet, but stunning Shetland, you'd never imagine the exciting life Fair Isle expert, Hazel Tindall has lived. From claiming the world's fastest knitter crown to becoming an internationally renowned expert and author of a new DVD, there's rarely time to down needles when you're Shetland's Hazel Tindall. We asked her about her life and knitting inspiration...

Where did your love of knitting originate?

My grandparents and aunt all lived with us – all the ladies were knitters. My mother had to knit to pay the bills and I helped by knitting Fair Isle yokes into machine-knit jumpers and enjoyed the creativity of creating something unique every time.

What drives your passion for Fair Isle?

I love seeing how the same pattern can look completely different when the colours are changed. There are so many patterns and Shetland yarn comes in hundreds of colours.

People say your technique is the best and the fastest...

The ladies I watched had to be efficient to produce high-quality knitwear quickly. I followed their practice. In 2004 I won the title *World's Fastest Knitter*, and again in 2008 ahead of the Guinness World Record Holder, Miriam Tegels.

What's your proudest knitting moment?

I enjoyed being a member of Shetland Guild of Spinners, Knitters, Weavers and Dyers

who produced the pattern book, *A Legacy of Shetland Lace*, and making my knitting DVD.

Where's your favourite place to knit?

Either in my kitchen, listening to a knitting podcast, or in my recliner chair in the sitting room, with the TV on!

Do you have a favourite yarn?

No specific yarn as long as it's Shetland! Either from Shetland Organic, Jamieson's of Shetland or Jamieson & Smith.

"I won the title of *World's Fastest Knitter* ahead of Guinness World Record holder, Miriam Tegels"

What would be your first piece of advice for anyone thinking of designing?

It won't make you rich! Also, when writing patterns for a Fair Isle jumper in several sizes plan carefully to ensure the patterns are correctly placed for symmetry and perfection where the shoulders meet.

How do you keep yourself motivated when a project isn't going to plan?

I knit, make notes, then write the pattern. I need motivation to write because once the knitting's done I want to start the next thing!

THE FINE ART OF FAIR ISLE KNITTING

A STEP BY STEP GUIDE THROUGH THE TRADITIONAL CRAFT OF SHETLAND

WITH SHETLAND'S HAZEL TINDALL



Let Hazel inspire you to create Fair Isle magic with her DVD, £25 from www.hazeltindall.com

PHOTOGRAPHY: DAVE DONALDSON. COVER DESIGN: JJ JAMIESON

Where do you get your inspiration?

I love meeting with, and learning from, other members of Shetland Guild of Spinners, Knitters, Weavers and Dyers. It's great to see what they are creating.

How did you get to be a Fair Isle expert?

By chance! I was sitting on a coach with Elizabeth Johnston (www.shetlandhandspun.com), and she asked if I knitted Fair Isle. When I said yes she asked if I'd go on a trip to America as a member of Shetland Guild of Spinners, Knitters, Weavers and Dyers. They had been asked to demonstrate spinning, Fair Isle knitting and lace knitting but had not found a volunteer for Fair Isle (I was not a guild member then). So in 1998 I went to America, joined the Guild and entered the world of expert knitters!

Do you have a super-project in mind for the future? Can you tell us about it?

My super-project is to de-clutter and become better organised. I know my head will be clearer once I do this and more patterns will be written.

My mother had to knit to pay the bills and I helped by knitting Fair Isle yokes into machine-knit jumpers"

What other hobbies do you indulge in?

I love to play cards, scrabble, walk and spend time with my grandchildren.

Where's your favourite place to shop for knitting materials?

Charity shops and auction sales!

Tell us about your latest DVD...

I've been filmed knitting a Fair Isle cardigan from start to finish. Knitting with two colours, grafting, using a knitting belt, raepin string and jumper board are all demonstrated. It was a massive project but very rewarding to hear that buyers have learned something from watching it. The trailer can be seen and the DVD ordered from, www.hazeltindall.com or as a download from www.vimeo.com/ondemand/hazeltindall. The cardigan pattern, with links to appropriate chapters of the film, can be downloaded from www.ravelry.com or www.LoveKnitting.com. 



NICOLA FLECK



3



2



NICOLA FLECK

NICOLA FLECK

4

5

- 1 The beauty of Fair Isle can often be found in the simplest of makes and a muted pallet
- 2 A neutral base shade like cream or beige will make your colourful, Shetland yarns zing!
- 3 Begin your Fair Isle journey the easy way with a bevy of stunning, colourful hats
- 4 & 5 Two-toned makes, like Hazel's gorgeous cushions are ideal for adding a traditional touch to a modern home

The puzzles page

Take a break with our quick puzzles and win prizes



A goodie bag from Abakhan worth £10

could be yours if you can solve our crossword! We'll put all the winners in a hat (a woolly one of course) and pick five lucky readers. Visit www.abakhan.co.uk to find out about new products and special offers.

How to enter: Send the correct answer and your name and address on a postcard to: *Knit Today* Crossword 114, 2nd Floor, Tower House, Fairfax Street, Bristol, BS1 3BN. The closing date for entries is 21 July 2015.

Sudoku

FILL IN THE BLANK CELLS SO THAT EVERY ROW, COLUMN, AND 3 X 3 BOX CONTAINS THE NUMBERS 1 TO 9.

		5		4		2		
9			8			6		
	3			6			5	
	9			7		3		
7		6						1
		2		1	6			4
1	4				2			6
		9			5	4		
			1					8

Crossword

Solve the clues, then rearrange the letters in the shaded squares to spell an English castle (7)

1		2		3			4		5		6		7	
						8								
9						10								
						11								
12	13													
				14								15		
16									17					
				18				19						
20									21					
					22	23								
24		25		26							27	28		29
30										31				
								32						
33														
									34					

ACROSS

- 1 Chocolate-iced cream cake (6)
- 8 English county (8)
- 9 Mountain goat with upright horns (7)
- 11 Citrus fruit with easily separated segments (9)
- 12 Delayed, overdue (4)
- 14 Eraser (6)
- 16 Stringed instrument with a circular body (5)
- 17 Cash, coins (5)
- 18 Thick dark syrup (7)
- 20 Snake with a hooded head (5)
- 21 Frequently, many times (5)
- 22 Garden handcart with one wheel (6)
- 27 Earnest request (4)
- 30 Driven by a desire to succeed and achieve (9)
- 32 Reserve for a particular purpose (7)
- 33 Cooking utensil (8)
- 34 Sudden sharp pain (6)

DOWN

- 1 Be outstandingly good at (5)
- 2 Smallest amount (5)
- 3 Press clothes flat (4)
- 4 Alter, become different (8)
- 5 Crooked, lopsided (5)
- 6 Restrict, confine (5)
- 7 Precious stone (5)
- 10 Building used to house horses (6)
- 13 South American river (6)
- 14 Duty list (4)
- 15 Calm and peaceful (6)
- 17 Sound made by a cat (4)
- 19 Vivid purple red colour (6)
- 23 Waterproof jacket (6)
- 24 Stop temporarily (5)
- 25 Concerned with, regarding (5)
- 26 Precipitous, having an almost vertical slope (5)
- 28 Acquire knowledge (5)
- 29 Legjoint (5)
- 31 Increase in size (4)

Last month's answers

ACROSS: 1 Resume, 8 Marmalade, 9 Drizzle, 10 Australia, 11 Hoe, 12 Loudest, 15 Try, 17 Proud, 18 Tornado, 20 Peach, 21 Pew, 23 Octagon, 28 Say, 29 Boulevard, 31 Oatmeal, 33 Velveteen, 34 Trifle. DOWN: 1 Red, 2 Seine, 3 Maze, 4 Crisis, 5 Marry, 6 Ladle, 7 Delay, 8 Meander, 11 Hut, 13 Oath, 14 Dune, 16 Reel, 17 Polo, 19 Abandon, 22 Way, 24 Chalet, 25 Above, 26 Quill, 27 Beret, 28 Shelf, 30 Star, 32 Lie. WINNING SOLUTION: FLORIDA

SKILL LEVEL



INTERMEDIATE

TECHNIQUES

- ◆ PATTERN STITCH
- ◆ BUTTONHOLES & NECKBANDS

KNIT TODAY
CHILDREN'S PATTERN

Nice and nautical!

Fill their wardrobes with easy-to-wear classic separates in seasonal shades by *Patons*

Pattern info



"When it comes to children you can't have enough cardis and tops!"



ROSEE,
EDITOR

Materials

✦ Yarn
Sweater
2 (3:3:3:4) x 100g balls of Patons 100% Cotton 4ply in main colour (MC) White (shade 01691)

1 (1:2:2:2) x 100g balls of Patons 100% Cotton 4ply in contrast colour (CC) Delta (shade 01729)

Cardigan

3 (4:5:5:6) x 100g balls of Patons 100% Cotton 4ply in Jade (shade 01726)

✦ Needles

1 pair of 3.25mm (UK 10, US 3) and 1 pair of 2.75mm (UK 12, US 2) knitting needles

✦ Accessories

2 stitch holders for sweater
1 stitch holder and 7 (8:9:9;10) buttons for cardigan

Yarn detail

✦ Patons 100% Cotton 4ply
www.makeitcoats.com
01484 681881

- ✦ 100% cotton
- ✦ 100g/330m (360yds)
- ✦ Machine wash at 40°C
- ✦ £4.85

Tension

32 sts to 10cm in width over pattern, using 3 2.5mm needles.

Special abbreviations

C3R knit the 3rd st on left hand needle but do not slip off needle, then knit first st and slip this off needle, then knit 2nd st and slip this st and 3rd st off needle together
ytb yarn to back
ytf yarn to front

✦ Turn to page 92 for full list of abbreviations



Pattern from Patons Leaflet 4013: Girls Nautical Classics, £2.85
www.coatscrafts.co.uk

STITCHES AND TECHNIQUES USED

MATTRESS STITCH SEAM

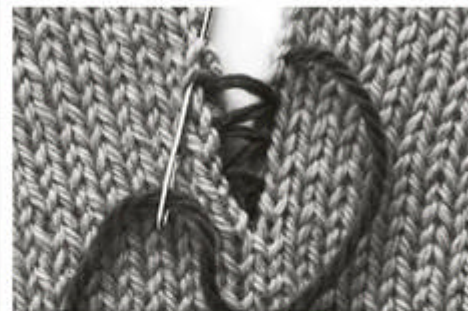

This seam is worked with the right side of work facing. Begin by bringing yarn up in the first row, between the first and second stitch. Insert the needle down in the corresponding position on the second piece and bring up 2 loops (2 rows) above. Re-insert down in the first piece where the yarn was originally drawn up and pass the needle under 2 rows and up to the front of the work.

Repeat this zigzag action, always taking the needle under loops that correspond exactly to the opposite side.

Work loosely, leaving seam stitches approx. 1cm wide.

When seam is about 2cm long, pull the thread gently to close the seam.

When the seam is complete, sew in ends. Remember to keep your work elastic – there should be as much stretch in your seam as there is in the knitted item.



NEATENING THE SIDE EDGE OF YOUR CAST ON

Before slipping the last cast on stitch on to the left-hand needle, pass the yarn from back to front between the points of the two needles, then slip the stitch on to the left-hand needle. This prevents a curved edge on the last stitch.

SWEATER BACK

Using 2.75mm needles and MC, cast on 109 (117:125:133:141) sts.

Row 1 (RS): K2, * p1, k1, rep from * to last st, k1.

Row 2: K1, * p1, k1, rep from * to end.

TO FIT AGE		4	6	8	10	12
TO FIT CHEST	cm	61	66	71	74	79
	in	24	26	28	29	31
ACTUAL CHEST	cm	66	72	78	82	87
	in	26	28½	30½	32½	34
SWEATER LENGTH	cm	38	42	46	48	50
	in	15	16½	18	19	19½
CARDIGAN LENGTH	cm	44	48	52	54	56
	in	17½	19	20½	21	21½
SHORT SLEEVE LENGTH	cm	6	6	6	6	6
	in	2½	2½	2½	2½	2½
LONG SLEEVE LENGTH	cm	28	33	38	40	42
	in	11	13	15	16	16½

Rep 1st and 2nd rows 4 times – 10 rows rib in all.

Change to 3.25mm needles and beg patt as follows

Row 1 using MC (RS): K5, * C3R, k5, rep from * to end.

Row 2 (WS): Purl.

Row 3 using CC: (K1, sl1 purlways) twice, k1, * sl 3 purlways, (k1, sl1 purlways) twice, k1, rep from * to end.

Row 4: (K1, sl1 purlways) twice, k1, * yft, sl 3 purlways, ybk, (k1, sl1 purlways) twice, k1, rep from * to end.

Rows 1 to 4 incl form patt.

Cont in patt until work measures approx 23 (26:29:30:32) cm, 9 (10¼:11½:12:12½) in from beg, ending with a 4th patt row.

SHAPE ARMHOLES

Keeping patt correct, cast off 5 (6:6:7:9) sts at the beg of the next 2 rows.

99 (105:113:119:123) sts

Dec one st at each end of next row, then in every foll alt row until 89 (95:101:105:107) sts rem. **

Cont in patt without shaping until armhole measures 15 (16:17:18:18) cm 6 (6¼:6¾:7:7), working last row on WS.

SHAPE SHOULDERS

Cast off 8 (9:9:10:10) sts at beg of next 4 rows, then 9 (9:10:9:9) sts at beg of foll 2 rows. Leave rem 39 (41:45:47:49) sts on a stitch holder.

FRONT

Work as for Back to **.

Cont in patt without shaping until armhole measures 8cm (3¼in) less than Back to beg of shoulder shaping, working last row on WS.

SHAPE NECK

Next row (RS): Patt 36 (38:39:40:40), turn.

*** Cont on these 36 (38:39:40:40) sts.

Dec one st at neck edge in every foll alt row until 25 (27:28:29:29) sts rem.

Cont in patt without shaping until armhole measures same as Back to beg of shoulder shaping, ending with same patt row on WS.

SHAPE SHOULDER

Cast off 8 (9:9:10:10) sts at beg of next row and foll alt row. Work 1 row. Cast off rem 9 (9:10:9:9) sts. ***

Slip next 17 (19:23:25:27) sts onto stitch holder and leave.

With RS facing, join yarn to rem sts and patt to end.

Rep from *** to ***, working 1 row more



A great mix of blue and white will forever be a nautical favourite

before shoulder shaping.

SHORT SLEEVES

Using 2.75mm needles and MC, cast on 77 (85:85:93:93) sts and work 10 rows rib as for lower band of Back.

Change to 3.25mm needles and beg patt. Work 20 rows patt as for Back.

SHAPE TOP

Keeping patt correct, cast off 3 (3:3:4:5) sts at beg of next 2 rows. 71 (79:79:85:83) sts.

Dec one st at each end of next row, then in every foll alt row until 15 (17:15:17:15) sts rem. Work 1 row. Cast off rem sts.

NECKBAND

Using mattress stitch seam, unless otherwise stated, join right shoulder seam. With RS facing, using 2.75mm needles and MC, pick

up and knit 30 sts evenly along left side of neck. Then knit across the sts on front stitch holder, dec 2 sts evenly at the same time. Pick up and knit 30 sts evenly along right side of neck, then knit the sts from the back stitch holder dec 3 sts evenly at the same time. 111 (115:123:127:131) sts. Work 7 rows rib as for lower band of Back, beg with a 2nd row. Cast off loosely in rib.

MAKE UP

Join left shoulder and neckband seam. Join side and Sleeve seams. Sew in sleeves. Sew in all ends.

CARDIGAN BACK

Work as for sweater back, working in one colour only throughout and working approx 29 (32:35:36:38) cm, 11½ (12½:13¾:14¼:15) ➔

BLOCKING DIAGRAM FOR BOTH GARMENTS

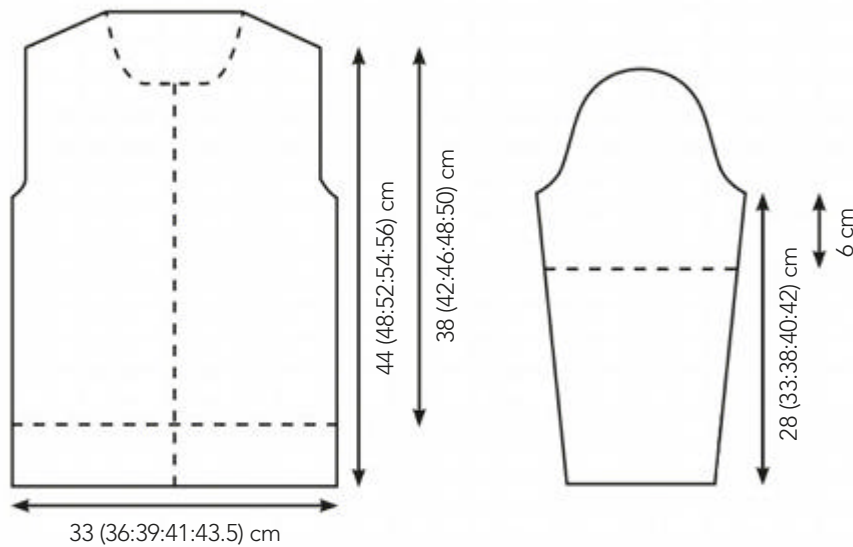

in to beg of armhole shaping, ending with a 4th patt row.

LEFT FRONT

Using 2.75mm needles, cast on 53 (61:61:69:69) sts.

Work 10 rows rib as for lower band of Back.

Change to 3.25mm needles and beg patt.

Work in patt as for Sweater Back, working in one colour only throughout until work measures approx 29 (32:35:36:38) cm 11½ (12½:13¾:14¼:15) in from beg, ending with a 4th patt row. **

SHAPE ARMHOLE

Keeping patt correct, cast off 5 (6:6:7:9) sts at beg of next row. 48 (55:55:62:60) sts.

Dec one st at armhole edge in every foll alt row until 43 (50:49:55:52) sts rem.

Cont in patt without shaping until armhole measures 8cm (3in) less than the Back to beg of the shoulder shaping, working last row on WS. Work 1 row.

SHAPE NECK

Cast off 8 (11:11:13:13) sts at beg of next row. 35 (39:38:42:39) sts

Dec one st at neck edge in next row, then in every foll alt row until 25 (27:28:29:29) sts rem.

Cont in patt without shaping until armhole measures same as Back to beg of shoulder shaping, ending with same patt row on WS.

SHAPE SHOULDERS

Cast off 8 (9:9:10:10) sts at beg of next row and foll alt row. Work 1 row. Cast off rem 9 (9:10:9:9) sts.

RIGHT FRONT

Work as for Left Front to **.

Work 1 row patt.

SHAPE ARMHOLE

Keeping patt correct, cast off 5 (6:6:7:9) sts at beg of next row. 48 (55:55:62:60) sts

Dec one st at armhole edge in next row, then in every foll alt row until 43 (50:49:55:52) sts rem.

Cont in patt without shaping until armhole measures 8cm (3in) less than Back to beg of shoulder shaping, working last row on WS.

SHAPE NECK

Cast off 8 (11:11:13:13) sts at beg of next row. 35 (39:38:42:39) sts

Dec one st at neck edge in every foll alt row until 25 (27:28:29:29) sts rem.

Cont in patt without shaping until armhole measures same as Back to beg of shoulder shaping, ending with same patt row on WS. Work 1 row patt.

SHAPE SHOULDER

Cast off 8 (9:9:10:10) sts at beg of next row and foll alt row. Work 1 row. Cast off rem 9 (9:10:9:9) sts.

LONG SLEEVES

Using 2.75mm needles, cast on 53 (53:61:61:61) sts. Work 10 rows rib as for lower band of Back.

Change to 3.25mm needles and beg patt. Work 8 rows patt as for Back, noting to work in one colour only throughout.

Cont in patt and working extra sts into patt,

inc one st at each end of next row, then in every foll 10th (8th:12th:10th:12th) row until there are 77 (85:85:93:93) sts.

Cont in patt without shaping until work measures approx 28 (33:38:40:42) cm 11 (13:15:15¾:16½) in from beg, ending with a 4th patt row.

SHAPE TOP

Complete as for Short Sleeves of Sweater.

NECKBAND

Use mattress stitch seam unless otherwise stated. Join shoulder seams. With RS facing and using 2.75mm needles, pick up and knit 36 (40:40:42:42) sts evenly along right front neck, knit across sts from back stitch holder dec 4 sts evenly at the same time, then pick up and knit 36 (40:40:42:42) sts evenly along left front neck. 107 (117:121:127:129) sts.

Work 7 rows rib as for lower band of Back, beg with a 2nd row. Cast off loosely in rib.

RIGHT FRONT BAND

With RS facing and using 2.75mm needles, pick up and knit 133 (153:173:173:193) sts evenly along right front edge.

For Girl: Work 3 rows rib as for lower band of Back, beg with a 2nd row.

Row 4: Rib 6, cast off 2 sts, * rib 18, cast off 2 sts, rep from * to last 5 sts, rib 5.

Row 5: Rib 5, turn, cast on 2 sts, turn, * rib 18, turn, cast on 2 sts, turn, rep from * to last 6 sts, rib 6. 7 (8:9:9:10) buttonholes.

Work 2 rows rib. Cast off in rib.

For Boy: Work 7 rows rib as for lower band of Back, beg with a 2nd row. Cast off in rib.

LEFT FRONT BAND

With RS facing and using 2.75mm needles, knit up 133 (153:173:173:193) sts evenly along left front edge.

For Boy: Work 3 rows rib as for lower band of Back, beg with a 2nd row.

Row 4: Rib 5, cast off 2 sts, * rib 18, cast off 2 sts, rep from * to last 6 sts, rib 6.

Row 5: Rib 6, turn, cast on 2 sts, turn, * rib 18, turn, cast on 2 sts, turn, rep from * to last 5 sts, rib 5. 7 (8:9:9:10) buttonholes.

Work 2 rows rib. Cast off in rib.

For Girl: Work 7 rows rib as for lower band of Back, beg with a 2nd row. Cast off in rib.

MAKING UP

Join side and sleeve seams. Set in sleeves.

Sew on buttons. Sew in all ends. 

back issues



Missing an issue of *Knit Today*? Complete your collection by ordering what you need*. And if you are a subscriber, you can save up to 15% off everything!



July Issue 113
FREE Pack of two bamboo needles



June Issue 112
FREE Stitch markers with tin plus tote pattern card



May Issue 111
FREE British Baby Knits booklet



April Issue 110
FREE Bunny knit kit and Louisa Harding pattern card



March Issue 109
FREE Three Stitch holders and Spring Knits book



February Issue 108
FREE Tape measure plus Kids' Knits book



January Issue 107
FREE Bamboo needles and Quick & Easy Knits book

3 EASY WAYS TO ORDER*:

- Call now on **0844 8440231**
Lines open weekdays 8am to 8pm and Saturday 9am to 1pm.
- Order online at www.subscribeonline.co.uk/immediate/backissues
- Order by post, complete and send us your order
Knit Today back issues, FREEPOST RRJZ-HJKA-ZBCX, Immediate Media Ltd, PO BOX 326, Sittingbourne ME9 8FA

*Subject to availability

BACK ISSUES ORDER FORM

Item	Subscriber	Non-subscriber	Issue no	Qty	Total
Back issue – UK	£5.35	£6.35			
Back issue – Europe	£7.35	£8.35			
Back issue – ROW	£8.35	£9.35			
GRAND TOTAL					£

YOUR DETAILS

Title _____ First name _____

Surname _____

Address _____

Postcode _____

Telephone number _____

Email address _____

PAYMENT OPTIONS

1. Cheque – I enclose a cheque made payable to Immediate Media Company Bristol Limited. Please write your name and address on the back of the cheque.

2. Credit / Debit card

Please debit my Mastercard Visa Maestro Visa Debit

Amount _____

Card number

 Valid from

--	--	--

 /

--	--	--

Expiry date

--	--	--

 /

--	--	--

Issue number (Maestro only)

--	--	--

Signature _____ Date _____

Your personal information will be used as set out in our Privacy Policy, which can be viewed at immediate.co.uk/privacy-policy.

GUIDE TO *knitting*

Use our *step-by-step* guide to learn the basics of knitting

Sponsored by Stylecraft Yarns
www.stylecraftyarns.co.uk

Stylecraft

MAKE A SLIPKNOT + YOUR FIRST CAST ON STITCH



1 Twist the yarn into a loop and form a second loop of yarn to pull through the first one.



2 Tighten the first loop into a knot around the second. This will be your first cast on stitch.

CAST ON – THUMB METHOD + USE THIS FOR A STRETCHY EDGE



1 Twist the yarn into a loop and form a second loop of yarn to pull through the first one.



2 Tighten the first loop into a knot around the second. This will be your first cast on stitch.



3 Wrap the ball end of the yarn anticlockwise around the needle. Push the needle through the loop.



4 Slide the loop off your thumb and tighten both ends. Repeat steps 2-4 for each stitch.

CAST ON – KNITTED ON METHOD + USE THIS FOR A STRONG, HARDWEARING EDGE



1 With the slipknot on your left needle, insert the right needle from front to back of the loop.



2 Wrap the ball end of the yarn anticlockwise around right needle and then pull this through the loop.



3 Now insert the left needle tip through the front of the new loop, dropping it off the right needle.



4 Repeat steps 1-3 as needed, forming new stitches from the top stitch on the left needle.

CAST OFF + HOW TO FINISH YOUR WORK



1 To begin, knit only the first two stitches in the cast off row.



2 Push the left needle through the first stitch, then lift it over the second stitch and off right needle.



3 With one stitch now on the right needle, knit another stitch and then repeat step 2 until the row end.



4 Cut the yarn with a 15cm or 6in tail. Pull the tail through the final cast off stitch.

KNIT + WORKED ON THE RIGHT SIDE IN STOCKING STITCH



1 Insert the right needle into the left needle's top stitch, from front to back with the yarn at the back.



2 Hold the yarn around your right index finger and then wrap it clockwise around the right needle.



3 Using the right needle, pull this new loop of yarn through the stitch on the left needle.



4 Ease the stitch off the left needle keeping the new stitch on the right needle. Repeat steps 1-4.

PURL + WORKED ON THE WRONG SIDE IN STOCKING STITCH



1 Insert the right needle into the front of the left needle's top stitch with the yarn in front.



2 With your right index finger, wrap the yarn anticlockwise around the top of the right needle.



3 Using the right needle, pull this new loop of yarn back through the front of the stitch.



4 Ease the stitch off the left needle, keeping the new stitch on the right. Repeat steps 1-4.

HOW TO FOLLOW A KNITTING PATTERN



Dress it up in cool...

SUMMER CARDIGAN

Materials

Tension

Size	16-18	18-20	20-22	22-24	24-26	26-28	28-30
Stitches	24	28	32	36	40	44	48
Rows	32	36	40	44	48	52	56

Special abbreviations

Purl

+ MATERIALS

Tells you recommended needle size, how much yarn for each size and whether you need any extra items, such as buttons or zips or other tools.

+ TENSION

How many rows and stitches per 10cm you need to knit your garment to the correct size. If you've got too many try a larger needle, if you've got too few, try a smaller needle.

+ ABBREVIATIONS

Special abbreviations are included with each pattern. All of our standard pattern abbreviations are listed on page 92 in this issue.

+ PURL OF WISDOM

You'll find top tips and ideas from expert knitters throughout *Knit Today*, to help you add to your knitting and crochet skills.

+ SIZING GUIDE

Consult the sizing guide to find measurements for all the different sizes you can knit your garment in, including length, and actual measurements.

Find this sweet Bow Belle bag on page 74

standard abbreviations

alt	alternate	p3tog	purl three stitches together
beg	beginning	pssso	pass slipped stitch over
ch	chain stitch	rem	remaining
cm	centimetre(s)	rep	repeat(ing)
cont	continue(ing)	rev st st	reverse stocking stitch
dc	double crochet	RS	right side
dec	decrease(ing)	skpo	slip 1st, k1, pass slipped
dpn	double-pointed needles		stitch over
dtr	double treble crochet	sl1/s1	slip one stitch
g st	garter stitch, knit every row	sl st	slip stitch
fol	following	ssk	one by one, slip the next 2 sts
htr	half treble crochet		knitwise. Put the left needle through
inc	increase(ing)	st(s)	the front loops of both slipped sts
in	inch(es)	st st	and knit them together
K	knit	tbl	stitch(es)
kfb	knit into front and back of next stitch	tr	stocking stitch
k2tog	knit two stitches together	WS	through the back of the loop(s)
k3tog	knit three stitches together	wyib	treble crochet
kwise	knitwise	wyif	wrong side
M1	make one stitch by picking up the	yb	with yarn in back
	horizontal loop before next stitch	yf/yfwd	with yarn in front
	and knitting into back of it	yoh	yarn back
meas	measure(s)	yo	yarn forward
P	purl	yorn	yarn over hook
PM	place marker		yarn over needle
p2tog	purl two stitches together		yarn round the needle

HOW TO READ KNITTING CHARTS

Knitting charts follow the same rules unless the pattern states otherwise. Right side rows are usually odd numbers and are worked right to left. Wrong side rows are normally even numbers and are worked left to right. Pattern repeats will be contained in an area outlined in red and some charts will have further coloured outlines for different sizes. The key will give you each symbol and tell you what stitch it is.

NEEDLE SIZE CONVERSION CHART		
METRIC SIZES	UK SIZES	US SIZES
2	14	0
2.25	13	1
2.75	12	2
3	11	2/3
3.25	10	3
3.5	10/9	4
3.75	9	5
4	8	6
4.5	7	7
5	6	8
5.5	5	9
6	4	10
6.5	3	10.5
7	2	10.5/11
7.5	1	10.5/11
8	0	11
9	00	13
10	000	15
12	–	17
16	–	19
19	–	35
25	–	50



download now!

Featuring the **best patterns**, the latest **knitting news** and **trends**, plus **interviews**, **techniques** and **reviews**, *Knit Today* is the **magazine for knitters just like you.**

Download your copy today!

- ◆ **iPad** <http://bit.ly/knittodayipad>
- ◆ **Zinio** <http://bit.ly/knittodayzinio>
- ◆ **Kindle Fire** <http://bit.ly/knittodaykindle>



Follow us on Facebook /KnitToday



Follow us on Twitter /KnitToday



Follow us on Pinterest /knittoday



Follow us on Instagram /knittoday magazine

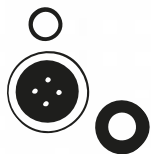

stockists

Artesano Yarns

Unit G, Lamb's Farm Business Park, Basingstoke Road, Swallowfield, Reading, Berkshire RG7 1PQ
☎ 0118 9503350
www.artesanoyarns.co.uk

Bergère de France

hello@bergerefrance.com
www.bergerefrance.co.uk

Blacker Yarns

Unit B Pipers Court, Pennygillam Way, Launceston, Cornwall PL15 7PJ
☎ 01566 777635
www.blackeryarns.co.uk

Brooklyn Tweed

www.brooklyntweed.com

Conway + Bliss

☎ 01535 664222
www.designeryarns.uk.com

Debbie Bliss

☎ 020 8520 8814
www.debbieblissonline.com

Deramores (incl Phildar)

☎ 0800 4880708
www.deramores.com

Designer Yarns

Units 8-10, Newbridge Industrial Estate, Pitt Street, Keighley BD21 4PQ
☎ 01535 664222
www.designeryarns.uk.com

DMC

Unit 21 Warren Park Way, Warrens Park, Enderby, Leicester LE19 4SA
☎ 0116 2754000
www.dmccreative.co.uk

Ella Rae

☎ 01535 664222
www.intercontinental yarns.co.uk

James C Brett

30/34 Clyde Street, Bingley West Yorkshire BD16 2NT
☎ 01274 565959
www.jamesc Brett.co.uk



Immediate Media Company Limited is working to ensure that all of its paper is sourced from well-managed forests. This magazine can be recycled for use in newspapers and packaging. Please remove any gifts, samples or wrapping and dispose of it at your local collection point.

King Cole Yarns

Merrie Mills, Elliott Street, Silsden, Keighley, West Yorkshire BD20 0DE
☎ 01535 650230
www.kingcole.co.uk

Knitwell

☎ 01274 722290
www.knitwell.co.uk

Louisa Harding

Units 8-10, Newbridge Ind Est, Pitt Street, Keighley BD21 4PQ
☎ 01535 664222
www.designeryarns.uk.com

LoveKnitting

☎ 0845 544 2196
www.loveknitting.com

Patons and Regia

Coats Crafts UK, Green Lane Mill, Holmfirth HD9 2DX
☎ 01484 681881
www.coatscrafts.co.uk

Rico Design

Rooftops, Crabtree Green, Collingham, West Yorkshire LS22 5AB
☎ 0203 0249009
www.rico-design.de

Rowan

Coats Crafts UK, Green Lane Mill, Holmfirth HD9 2DX
☎ 01484 681881
www.knitrowan.com

Rooster Yarns

☎ 01829 740903
www.roosteryarns.com

Sirdar

Sirdar Spinning Ltd, Flanshaw Lane, Alverthorpe, Wakefield WF2 9ND
☎ 01924 371501
www.sirdar.co.uk

Stylecraft

PO Box 62, Goulbourne Street, Keighley BD21 1PP
☎ 01535 609798
www.stylecraft-yarns.co.uk

Sublime

Sirdar Spinning, Flanshaw Lane, Alverthorpe, Wakefield WF2 9ND
☎ 01924 369666
www.sublimeyarns.com

Thomas B. Ramsden

Netherfield Road, Guiseley, Leeds, LS20 9PD
☎ 01943 872264
www.tbramsden.co.uk

West Yorkshire Spinners

Unit 2 Airedale Park, Royd lngs Avenue, Keighley, BD21 4DG
☎ 01535 664500
www.wyspinners.com

Wool Warehouse

☎ 0800 505 3300
www.woolwarehouse.co.uk



knit today

Published monthly by Immediate Media Co, 2nd Floor, Tower House, Fairfax Street, Bristol BS1 3BN
Tel: 0117 9279009

EDITORIAL



Editor

Rosee Woodland
rosee.woodland@immediate.co.uk



Art editor

Charlene Lim
charlene.lim@immediate.co.uk



Designer

Benedict Blyth
benedict.blyth@immediate.co.uk

Advertising manager

Rachael Hawkins
rachael.hawkins@immediate.co.uk
0117 3008283

Technical editor

Joanna Benner
Editorial contributors Hannah Bellis, Carolyn Bunt, Cecilia Forfitt, Diane Hollands, Sophie Jordan, Carol McCormick, Kirstie Sleight

Photography

Paul Buller, Jesse Wild, Steve Sayers
Models Megan Morewood, Beth Ivey-Williams, George Wildman, Daisy Duhig, Henry Duhig.

Hair and make up

Jyn San

ADVERTISING & MARKETING

Group advertisement manager

Penny Stokes
penny.stokes@immediate.co.uk

Ad coordinator

Emily Thorne

Ad designer

Rachel Shircore

Marketing coordinator

Natalie Medler

PRODUCTION

Production director

Sarah Powell

Production manager

Rose Griffiths

Repro

Tony Hunt, Chris Sutch

PUBLISHING

Editor-in-chief

Deborah Bradley

Group publisher

Kerry Lawrence

Managing director

Andy Marshall

Distribution

Frontline
Printed in England by William Gibbons

INTERNATIONAL LICENSING

Knit Today is available for licensing overseas.

Call Bruce Sawford Licensing on 01280 860185 or

email bruce@brucesawfordlicensing.com

DISTRIBUTION

Knit Today is published 13 times a year and is available

through leading newsagents and supermarkets in the UK.

SUBSCRIPTIONS

BAR rates: UK £43 annually, EUR £60 annually, ROW £70

annually

To subscribe, call the Subscription Hotline 0844 8440231

Overseas Subscription Hotline +44 (0)1795 414612

Subscription email knittoday@servicehelpline.co.uk

IMMEDIATE MEDIA CO

Immediate Media Co is dedicated to producing the very best consumer specialist interest magazines. Our magazines are edited and designed to inform our readers, enhance their lives and give them the best value for money possible. We take great care to ensure all elements of *Knit Today* are accurate. However, we accept no liability for any misprints or mistakes that appear in this magazine. © Immediate Media Co 2015. Our policy on photocopying/scanning and resale We are happy for you to photocopy or scan our projects for personal use only. You may also photocopy or scan subscription, mail order coupons and competition entry forms (but only one photocopy or scan per reader). Patterns from this issue may not be resold.

knit today

For all your knitting essentials...

To advertise in the classified section
please call Emma Hunter on
0117 314 7398

ESSEX

Peachey Ethknits

Sirdar, Sublime, Rowan, Regia, Patons etc. yarns
Plus Cross Stitch and Tapestry Kits and
accessories

ALL ON SALE WHILE STOCKS LAST

E: ethknits@gmail.com | Tel: 44(0)1245 327006
www.ethknits.co.uk



ESSEX

The Wool Cabin

from Curtains to Cushions

EXTENSIVE YARN RANGE
28 High Street, Clacton-On-Sea,
Essex CO15 1UQ
01255 428352
**Now also at
branch**
71 Connaught Avenue, Frinton,
Essex CO13 9PP 01255 674456
Yarn, Haberdashery Linen,
Fabrics Craft & Babywear
sandra_woolcabin@hotmail.com

STAFFORDSHIRE

The Knitting Corner



Visit us for a coffee and a chat in our exciting shop.
We stock Rowan, Debbie Bliss, Noro, Sublime and
more. Join us for informal classes, full-day
workshops and our Knitting Club held
on alternate Fridays.
Mail order available.
Open Wednesday to Sunday 10.30am to 4.30pm
The Knitting Corner, Unit 3, The Mill,
Curborough Hall Farm, Watery Lane,
Lichfield, Staffs WS13 8ES
Tel: 01543 415837
theknittingcorner@virginmedia.com
www.facebook.com/theknittingcorner

To advertise in the classified section please call
Emma on: 0117 314 7398

DEVON

Spin A Yarn
Exciting, unusual and natural yarns from around the world

26 Fore Street Bovey Tracey Devon TQ13 9AD
Tel: 01626 836203
email: info@spinayarndevon.co.uk
www.spinayarndevon.co.uk

SOMERSET

MATERIAL NEEDS

KNITTING, CROCHET, NEEDLECRAFT & HABERDASHERY
.....also for the best in dress & quilting fabrics.

www.material-needs.co.uk - Tel: 01278 794 751

79 High Street,
Burnham-on-Sea,
Somerset TA8 1PE

SOUTH WALES

Ammonite Yarns
Bringing Wool to Wales

We stock: Wendy; Robin; Peter Pan; West
Yorkshire Spinners; Fyberspates; Woolyknit and
Drops plus some local independent dyers too.

Find us on facebook at Ammonite Yarns
Use the discount code 02August5 and receive 5% off online or in store.
Ammonite Yarns, 7 Llantrisant Road, Pontyclun CF72 9DP
Tel: 01443 520200
www.ammoniteyarns.moonfruit.com

WALES' NEWEST
WOOL SHOP

DEVON

Fiddlesticks Devon

We specialize in Bergere de France yarns

sales@fiddlesticksdevon.co.uk
07530 530754

www.fiddlesticksdevon.co.uk

ONLINE

The
Happy Knitter
Your Friendly Online Wool Shop

For quality wools at a great price!

www.thehappyknitterwoolshop.co.uk
Tel : 01387 265713 - info@thehappyknitterwoolshop.co.uk

WEST MIDLANDS

Withit Witch The Halesowen Knitting Centre

Yarns and Patterns from Sirdar,
Stylecraft, James C Brett and Rico
enquiries@withitwitch.co.uk
www.withitwitch.co.uk



75 High Street
Halesowen B63 3BQ
0121 550 0201

YORKSHIRE

Anne's Flowers & Crafts

Many yarns available including
Sirdar, Rico, Wendy, Debbie Bliss,
Adriañil & Stylecraft.

Haberdashery and fresh flowers
Local deliveries or mail order.

Tel: 01924 494157
119-121 Nab Lane, Mirfield WF14 9QJ

Rowan Stockist Guide

Looking to buy from the Rowan range? These shops can help you find what you need.
Drop into your local shop, give them a call or buy online.



1. ABERDEEN



Wool for Ewe

01224 643 738

www.woolforewe.com

info@woolforewe.com

An independent, family-run business offering yarns to suit every budget and patterns for every style. We also offer workshops for those looking to improve their knitting or crochet skills.

2. CASTLE DOUGLAS



Outback Yarns

01556 504 900

www.outbackyarns.co.uk

sarah@outbackyarns.co.uk

For all your woolly needs in one place! We stock yarns, patterns and everything else you may need. If you want it we've got it – along with help and a smile.

3. DERBYSHIRE



Threads of Life

01332 811597

www.threadsoflife.co.uk

An Aladdin's cave of lovely things for yarn addicts, to suit many tastes and budgets. Helpful advice always available, as well as regular workshops. Visit the website for more information.

4. WORCESTERSHIRE



Sew U Knit Crafts

01386 853779

www.sewuknitcrafts.co.uk

sewuknitcrafts@outlook.com

Stockist of a wide variety of accessories for knitting, crocheting & sewing, as well as books, magazines, crafting bags, haberdashery and cross stitch, tapestry & craft kits.

Want to be involved in the next stockist guide?

Get in touch with Emma on

0117 314 7398



KIRSTIE ALLSOPP
PRESENTS

THE HANDMADE FAIR

HAMPTON COURT PALACE
18TH - 20TH SEPTEMBER 2015

PROUDLY SPONSORED BY



IN ASSOCIATION WITH



EVERYONE HAS A CRAFT THEY CAN DO

JOIN KIRSTIE ALLSOPP AND LEADING EXPERTS FOR A LONG WEEKEND OF CRAFTING! BE ENTERTAINED IN THE SUPER THEATRE, DEVELOP YOUR TECHNIQUES IN THE SKILLS WORKSHOPS, JOIN 300 FELLOW ENTHUSIASTS IN THE GRAND MAKES, PLUS SHOP TO YOUR HEART'S CONTENT IN THE BOUTIQUE SHOPPING VILLAGE - ALL INCLUDED IN YOUR FULL EXPERIENCE OR VIP TICKETS.

BOOK TODAY AT THEHANDMADEFAIR.COM OR CALL 0871 230 7153

CALLS COST 10P PER MINUTE PLUS NETWORK EXTRAS. BOOKING AND TRANSACTION FEES APPLY.



THE HANDMADE FAIR



@HANDMADEFAIR



THE HANDMADE FAIR

WorldMags.net

NEXT MONTH IN KNIT TODAY

Knit today



LACY JUMPER

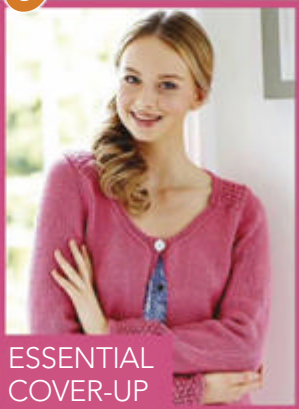

ESSENTIAL COVER-UP

inside...

- ✦ CROPPED CARDI
- ✦ TEXTURED VEST
- ✦ STRIPY SUN HAT

ALL DESIGNS sizes 8-22

GET INVOLVED

CHARITY KNITS + EXCITING GIVEAWAYS

Knits for summer!

- ✦ FASHION LOOKS
- ✦ BABY CLOTHES
- ✦ HOMEWARE IDEAS
- ✦ CUDDLY TOYS

Your handy **KNITTING GAUGE**

GET THE RIGHT NEEDLE SIZE EVERY TIME!



free **FOXY KNITTING GAUGE**

EXPERT ADVICE

YOUR QUESTIONS ANSWERED!



COSY JACKET



CUTE BULLDOG

Fabulously fun knits!



FOOTBALL BAG



PRETTY CARDI

ISSUE 115 ON SALE TUESDAY 21 JULY



When is a designer not a designer?

Benedict Blyth is not the next Kaffe Fassett but he is the new designer on the Knit Today team

There are plenty of things to typically worry about when you start a new job. What's the best way to get to the office? Should you dress up or down on your first day? Which biscuit will go down best with the new colleagues? (I've now learnt that M&S pistachio and almond biscuits make me popular with the team here – other brands of biscuits are available, and also popular.) But joining *Knit Today* has brought its own concerns, most notably that I can't actually knit.

Surely this would not be a problem, I told myself. I'm the team's designer, which means I assist with the creation of the pages and styling the models on the photo shoots. I don't actually need to know how to knit. But in the run up to my first day of work, I told a female friend that I was going to be the new designer at *Knit Today*. "Benedict, that's amazing!" she exclaimed. "I never even knew you were a knitter, let alone a designer! What are you working on at the moment?" It took me a while to understand the association – a designer in the world of knitwear is a very different role to a designer in the field of publishing. And straddling the two spheres

I was going to have to be careful how I explained my new role to people before they assumed I was an up and coming Kaffe Fassett.

My first day was no gentle easing in – I was on location with art editor Charlene and I spent the day assisting models, fluffing up knitwear and lugging lighting and camera equipment from room to room in a beautiful stately home – I even got the ironing board out to make sure that the models looked perfectly crisp. My second day saw me back in the studio, with editor Rosee, shooting some knitting step by steps:

This is when I started to relax about my lack of knowledge. With expert knitters like these on the team, I was in safe hands, and certainly nobody was expecting me to create the next colourful cardigan for

"A designer in the knitwear world is very different to a designer in the field of publishing"

the magazine – phew! A few issues in, I have even started to pick up some of the knitting basics; I can successfully cast on and off, and the strings of letters in the patterns have started to actually mean something to me – some of the time, anyway. Surely a pair of socks are not too far away! On second thoughts, my colleagues have advised me to start with a scarf as they are the easiest, apparently. Excellent, there's another fact I've learnt in my ongoing knitting education.

I don't think it will ever be my hands you see in the technical step by steps, but I'll be the man behind the camera, making sure the focus is right and the images are the very best they can be. It's for the best

I don't think my hands are quite pretty enough to make it into print. bt

next month

CHARLENE,
ART EDITOR

"Is the sun shining? Knits this bright always need shades!"



From above left: Quick knits for men, from issue 105; legendary designer Kaffe Fassett; Rosee's hands are the models in our step-by-steps; Benedict arranges props at a shoot





Patons



Baby Smiles

made with loving care



Baby Moments – Magazine 001
Patons Fairytale Dreamtime 4ply
or Patons Fairytale Fab 4ply

Make it

COATS

makeitcoats.com

WorldMags.net

deramores

THE ONLINE KNITTING
AND CROCHET STORE

EASY ONLINE SHOPPING

- OVER **800** YARNS
- **NEW** PRODUCTS ADDED EVERY WEEK
- **FREE DELIVERY**** & **SAME DAY DESPATCH**



FREE
PATTERNS!

15% OFF YOUR NEXT ORDER*

ENTER THE COUPON CODE **KT114** ON THE SHOPPING BASKET PAGE

*One use per customer. Terms and conditions apply.

**On orders over £25. Image from Aran Book 2 by King Cole.

www.deramores.com ORDER LINE ☎ 0800 488 0708

Yarn • Patterns • Books • Needles • Buttons • Accessories

8 SUMMER MAKES

In association with



www.dmccreative.co.uk



COSY SHAWL



CHUNKY BANGLES



LACY HEADBAND



COOL CUSHION



...AND OUR CUDDLY OCTOPUS!



STRIPY BEACH BAG



WELCOME



This month we bring you our free mini collection of brilliant makes using the new DMC Natura XL yarn.

A versatile, 100% cotton yarn, it's perfect for knitting our headband, bangles, shawl and octopus, *and* crocheting our bag and cushion. But the fun doesn't end there, we've also created an adorable, knitted octopus toy for you! He's incredibly soft and cuddly and a must have for animal-mad children everywhere. Happy summer!



Follow us on Facebook /KnitToday



Follow us on Twitter /KnitToday



Follow us on Pinterest /knittoday



Follow us on Instagram /knittoday magazine

Rosee Woodland, Editor

CONTENTS

- | | | | |
|-----|---|-----|---|
| p4 | SUMMER SHAWL
Give summer breezes the cold shoulder with this quick-to-knit shawl in stunning bold stripes | p16 | COOL CUSHION
Treat your deck chair and your derrière with our soft cushion, worked in attractive crochet stitches |
| p10 | CHUNKY BANGLES
Up your fashion credentials with soft knitted jewellery that looks perfect for the summer months | p22 | BEACH BAG
Make sure you're all kitted up with the right crochet bag! This one's perfect for summer holidays |
| p14 | LACY HEADBAND
Keep cool in the sun (and wayward hair neat and tidy) with this pretty, pastel-pink headband | p28 | JOLLY OCTOPUS
Give our sensational knitted octopus a try – he's squidgy, cuddly and completely lovable! |



SKILL LEVEL



BEGINNER

SUMMER SHAWL

Keep yourself warm as the sun goes
down with our seasonal accessory.

By Helen Ardley



Pattern info

“The DMC Naura XL range comes in 30 beautiful colours so can mix and match your colours to suit a favourite summer outfit”



ROSEE,
EDITOR

Materials

- ✦ Yarn
- 1 ball of DMC Naura XL Super Chunky 100g in each of the following shades:
 - A Dusky Orange (101)
 - B Grey (12)
 - C Black (02)
 - D Bright Teal (81)

SHAWL

With colour A cast on 3 sts.

Row 1: Knit.

Row 2: K1, m1, k2. 4 sts

Row 3: (K1 wrap) 3 times, m1 wrapping twice around st, k1 wrapping twice around sts. 5 sts

- ✦ Needles

1 pair 9mm (UK 00, US 13) needles

Yarn detail

- ✦ DMC Naura XL Super Chunky Just Cotton
www.dmccreative.co.uk
- ✦ 100% cotton
- ✦ 100g/75m or 82 yds (82 yards)
- ✦ Machine washable at 30°C
- ✦ £4.89

Tension

7 sts and 10 rows to 10cm or 4in measured over pattern on 9mm needles

Finished size

92cm x 80cm or 36in x 31in

Special abbreviations

cont	continue(ing)
st(s)	stitch(es)
K	knit
K1 wrap	wrap yarn twice around the needle for each st
k2tog	knit two stitches together
m1	make one stitch, by picking up the horizontal loop before next stitch and knitting into back of it

Row 4: Knit each st dropping extra loop.

Row 5: K4, m1, k1. 6 st

Row 6: K1, m1, k5. 7 sts

Row 7: K6, m1, k1. 8 sts

Row 8: K1, m1, k7. 9 sts

Row 9: (K1 wrap) 8 times, m1



Not a fan of stripes? Knit this gorgeous shawl in just one shade instead, using four balls of yarn



FABULOUS!

To create the shawl's loose pattern some of the stitches are worked by wrapping the yarn around the needle twice

wrap, k1 wrap. 10 sts

Row 10: Knit each st, dropping extra loop.

Row 11: K9, m1, k1. 11 sts
Change to colour C.

Row 12: K1, m1, k10. 12 sts

Row 13: K11, m1, k1. 13 sts

Row 14: K1, m1, k12. 14 sts

Row 15: (K1 wrap) 13 times, m1 wrap, k1 wrap. 15 sts

Row 16: Knit each st, dropping extra loop.

Row 17: K14, m1, k1. 16 sts

Row 18: K1, m1, k15. 17 sts

Row 19: K16, m1, k1. 18 sts

Row 20: K1, m1, k17. 19 sts

Row 21: (K1 wrap) 18 times, m1 wrap, k1 wrap. 20 sts

Row 22: Knit each st, dropping extra loop.

Row 23: K19, m1, k1. 21 sts
Change to colour B.

Row 24: K1, m1, k20. 22 sts

Row 25: K21, m1, k1. 23 sts

Row 26: K1, m1, k22. 24 sts

Row 27: (K1 wrap) 23 times, m1 wrap, k1 wrap. 25 sts

Row 28: Knit each st, dropping extra loop.

Row 29: K24, m1, k1. 26 sts

Row 30: K1, m1, k25. 27 sts

Row 31: K26, m1, k1. 28 sts

Row 32: K1, m1, k27. 29 sts

Row 33: (K1 wrap) 28 times, m1 wrap, k1 wrap. 30 sts

Row 34: Knit each st, dropping extra loop.

Row 35: K29, m1, k1. 31 sts
Change to colour D.

Row 36: K1, m1, k30. 32 sts

Row 37: K31, m1, k1. 33 sts

Row 38: K1, m1, k32. 34 sts

Row 39: (K1 wrap) 33 times, m1

wrap, k1 wrap. 35 sts

Row 40: Knit each st, dropping extra loop

Row 41: K34, m1, k1. 36 sts

Row 42: K1, m1, k35. 37 sts

Row 43: K36, m1, k1. 38 sts

Row 44: K1, m1, k37. 39 sts

Row 45: (K1 wrap) 38 times, m1 wrap, k1 wrap. 40 sts

Row 46: Knit each st, dropping extra loop.

Row 47: K39, m1, k1. 41 sts
Change to colour A.

Continue increasing as set and changing colour every 12 rows until you have 62 sts.

Change to colour B and start the decreasing.

Next row: K2tog, k to end.

Next row: K to last 2sts, k2tog.

Next row: K2tog, k to end.

Next row: Wrap each st to last 2 sts, wrap k2tog.

Next row: Knit each st, dropping extra loop.

Next row: K to last 2sts, k2tog.

Next row: K2tog, k to end.

Next row: K to last 2 sts, k2tog.

Next row: K2tog, k to end.

Next row: Wrap each st to last 2sts, wrap k2tog.

Next row: Knit each st, dropping extra loop.

Next row: K to last 2sts, k2tog.

Change to colour D and cont decreasing as last 12 rows until you have 3 sts.

Work 6 rows in garter stitch.

Cast off.

Sew in all loose ends. 



SKILL LEVEL



EASY



A COLLECTION OF PRETTIES

Make the perfect gifts for fashionable friends, daughters and granddaughters.

By Helen Ardley

*knit
it!*

WorldMags.net

Pattern info

“Knitted jewellery and accessories are very popular on the high street! Add your own handmade touch with this set”



CHARLENE,
ART
EDITOR

Materials

- ✦ Yarn
1 ball of DMC Natura XL Super Chunky 100g in each of the following shades:
A Aqua (07)
B Dusky Pink (61)
C Brick (42)
- ✦ Needles
1 pair 8mm (UK 0, US 11) needles
1 8mm (UK 0, US 11) cable needle
- ✦ Accessories
3 wooden bangles with a 7cm or 2¾in girth
2 wooden buttons for headband

Yarn detail

- ✦ DMC Natura XL Super Chunky

Just Cotton
www.dmccreative.co.uk

- ✦ 100% cotton
- ✦ 100g/75m or 82 yds (82 yards)
- ✦ Machine washable at 30°C
- ✦ £4.89

Tension

11 sts and 14 rows to 10cm measured over pattern on 8mm needles

Finished size

Headband size: 10cm x 55cm or 4in x 22in

Special abbreviations

- c4b** slip 2 stitches to cable needle, hold at back of work, knit two stitches from left-hand needle, knit 2 stitches from cable needle
- K** knit
- k2tog** knit two stitches together
- m1** make one stitch, by picking up the horizontal loop before next stitch and knitting into back of it
- P** purl
- p3tog** purl three stitches together
- psso** pass slipped stitch over
- rep** repeat
- sl1** slip 1 to right-hand needle
- st(s)** stitch(es)
- yf** yarn forward
- yrn** yarn round the needle



GORGEOUS!

Using this great pattern as a base, you could weave ribbons, leather or cord through your headband for a true festival-inspired touch!

HEADBAND

With 8mm needles and colour B cast on 3 sts.

Work 6 rows in garter stitch.

Row 7 (RS): K1, m1, k1, m1, k1.

5 sts

Work 6 rows in garter stitch.

Row 14: K2, m1, k1, m1, k2

Row 15: K2, p3, k2.

Row 16: Knit.

Row 17: K2, p3, k2.

Rep last 2 rows once more.



These bangles come in garter stitch, moss stitch and cable so you can choose your favourite pattern!

Row 20: K2, m1, k3, m1, k2. 9 sts

Row 21: K2, p5, k2.

Row 22: K3, yrn, p3tog, yf, k3.

Row 23: K2, p5, k2.

Row 24: K2, m1, k5, m1, k2. 11 sts

****Row 25:** K2, p7, k2.

Row 26: K2, yrn, p3tog, yf, k1, yrn, p3tog, yf, k2.

Row 27: K2, p7, k2.

Row 28: Knit.

Row 29: K2, p7, k2.

Row 30: K4, yrn, p3tog, yf, k4.

Row 31: K2, p7, k2.

Row 32: Knit ***

Rep from ** to *** until work measures (when slightly stretched) 39cm or 15½in, ending after row 27.

Next row (RS): K2, k2tog, k3, k2tog, k2.

Next row: K2, p5, k2.

Next row: K3, yrn, p3tog, yf, k3.

Next row: K2, p5, k2.

Next row: Knit.

Next row: K2, p5, k2.

Next row: K2, k2tog, k1, k2tog, k2.

Next row: K2, p3, k2.

Next row: Knit.

Next row: K2, p3, k2.

Next row: K2, sl1, k2tog, pss0, k2 work 5 rows in garter stitch.

Next row: K2tog, k1, k2tog.

Work 6 rows in garter stitch.

Cast off.

Sew in all loose ends.

Sew two buttons to right side of the garter stitch at beg and use the holes on the knitting as button holes.

BANGLE 1

With 8mm needles and colour B cast on 6 sts.

Work in garter stitch until band measures 26cm (10½in), enough to fit when slightly stretched around the outside of the bangle. Cast off.

Sew cast off edge to cast on edge. Place bangle inside knitted band and sew together pulling edges together on the inside of bangle, covering all the wooden bangle. In colours A and C cut 10cm lengths of yarn. Attach to the outside of bangle in alternate colours and trim to length required.

BANGLE 2

Cast on 8 sts using colour A.

Row 1: P2, k4, p2.

Row 2: K2, p4, k2.

Row 3: P2, c4b, p2.

Row 4: As 2nd row.

Row 5: As 1st row.

Row 6: As 2nd row.

Rep last 4 rows until work measures 25cm (10in).

Cast off.

Sew together as bangle 1.

BANGLE 3

Cast on 7 sts in colour A.

Row 1: K1,* p1, k1 rep from * to end.

These row forms the moss stitch.

Rep last row three times more.

Change to colour C.

Work 2 rows in moss stitch.

Change to A.

Work 4 rows in moss stitch.

Continue in stripe until work measures 25cm (10in).

Cast off.

Sew together as bangle 1. 



SKILL LEVEL



INTERMEDIATE



OH SO COOL & COMFY

Get ready to sit back and relax into
this dreamy, cool blue cushion.

By Helen Ardley

crochet
it!

WorldMags.net

Pattern info

“We love the blues, but this cushion would look great in soft neutrals and exotic spice colours too!”



ROSEE,
EDITOR

Materials

- ✦ Yarn
- 1 ball of DMC Natura XL Super Chunky 100g in each of the following shades:
- A Pale Sky (73)
- B Mid Teal (07)
- C Dark Teal (71)
- D Dusky Blue (72)

CUSHION

With colour B make 38ch.

Row 1: 1dc into 2nd ch from hook, 1 dc into next ch, *1htr into each of next 2ch, 1 tr into each of next 2ch, 1dtr into each of next 3ch, 1tr into each of next 2ch, 1htr into each of next 2ch, 1dc into each of next 3dc, rep from * once more,

- ✦ Hooks
- 8mm (UK 0, US L/11) crochet hook
- ✦ Accessories
- 11 buttons

Yarn detail

- ✦ DMC Natura XL Super Chunky Just Cotton
www.dmccreative.co.uk
- ✦ 100% cotton
- ✦ 100g/75m or 82 yds (82 yards)
- ✦ Machine washable at 30°C
- ✦ £4.89

Tension

8 sts and 7 rows to 10cm or 4in measured over pattern on 8mm crochet hook

Finished size

40cm x 40cm or 15¾in x 15¾in

Special abbreviations

ch(s)	chain(s)
cont	continue(ing)
dc	double crochet
dtr	double treble crochet
htr	half treble
rep	repeat
st(s)	stitch(es)
tr	treble crochet

1htr into each of next 2ch, 1tr into each of next 2ch, 1dtr into each of next 3ch, turn.

Change to colour A.

Row 2: 1ch, 1dc into each st to end, turn.

Change to colour C.

Row 3: 4ch (counts as first dtr), miss first st, 1dtr into next dc, *1tr



Good news!
There's no need
to create button
holes with this
chunky crochet
pattern, just sew
on your buttons
and you're done!



STYLISH!

The mix of double crochets, half trebles and trebles creates the attractive wave pattern which is perfect for summer time



into each of next 2dc, 1htr into each of next 2dc, 1dc into each of next 3dc, 1htr into each of next 2dc, 1 tr into each of next 2dc, 1 dtr into each of next 3dc, rep from * once more, 1tr into each of next 2dc, 1 htr into each of next 2dc, 1dc into each of next 3dc, turn.

Row 4: 1ch, 1dc into each st to end, turn.

Change to colour D.

Row 5: 1ch, 1dc into each of next 2dc, *1htr into each of next 2dc, 1 tr into each of next 2dc, 1dtr into each of next 3dc, 1tr into each of next 2dc, 1htr into each of next dc, 1dc into each of next 3dc, rep from * once more, 1htr into each of next 2dc, 1tr into each of next 2ch, 1dtr into each of next 3ch, turn.

Change to colour B.

Row 6: 1ch, 1dc into each st to end, turn.

Change to colour A, work rows 3 and 4.

Change to colour D, work row 5.

Change to colour C, work row 6.

Change to colour B, work row 3.

Change to colour D, work row 4.

Change to colour B work as row 5.

Change to colour A, work as row 2.

The last 12 rows form the pattern.

Cont in pattern until work measures 79cm (31in) finishing on row 5.

Sew in all loose ends.

Fold in half and sew down each side seam.

Sew onto the inside, following the wave design, 11 buttons and use the pattern on the front as button holes.



WorldMags.net

SKILL LEVEL



INTERMEDIATE

READY FOR THE BEACH?

Make sure you're perfectly packed
when it comes to time in the sun.

By Helen Ardley

*crochet
it!*

Pattern info

“Seventies boho style is going to be big for summer 2015 and that means crochet galore! Add your own individual touch with tassels or beads to finish the look”



CHARLENE,
ART
EDITOR

Materials

- ✦ Yarn
 - 1 ball of DMC Natura XL Super Chunky 100g in each of the following shades:
 - A Bright Orange (10)
 - B Acid Yellow (82)
 - C Bright Pink (43)
 - D Brown (111)
 - E Red (05)
- ✦ Hooks
 - 8mm (UK 0, US L/11) crochet hook

Yarn detail

- ✦ DMC Natura XL Super Chunky Just Cotton
 - www.dmccreative.co.uk
- ✦ 100% cotton
- ✦ 100g/75m or 82 yds
- ✦ Machine washable at 30°C
- ✦ £4.89

Tension

11 sts and 5 rows to 10cm or 4in measured over pattern on 8mm crochet hook

Finished size

23cm x 44cm or 9in x 17¹/₃in

Special abbreviations

beg	begin(ning)
ch(s)	chain(s)
cont	continue(ing)
dc	double crochet
dtr	double treble crochet
htr	half treble
rep	repeat
sl st	slip stitch
st(s)	stitch(es)
tr	treble crochet



Shorten your bag by working fewer repeat rounds, but remembering to keep your colour changes in the right order as you go!



PRACTICAL!

To make a thicker bag strap, work more double crochet rows after you've made the strap with chain stitch, alternating colours as you go

BAG

With 8mm hook and colour A make 5ch, sl st into first ch to form a ring.

Round 1: 3ch (counts as first tr), 15tr into ring, sl st into top of 3ch at beg of round. 16tr

Change to colour B.

Round 2: 3ch (counts as first tr), 1tr into base of 3ch, 2tr into each tr to end, sl st into top of 3ch at beg of round. 32tr

Change to colour C.

Round 3: 3ch (counts as first tr), 2tr into next tr, (1tr into next tr, 2tr into next tr) 15 times, sl st into top of 3ch at beg of round. 48tr

Change to colour D.

Round 4: 3ch (counts as first tr), 1tr into next tr, 2tr into next tr, (1tr into each of next 2tr, 2tr into next tr) 15 times, sl st into top of 3ch at beg of round. 64tr

Change to colour E.

Now work in pattern as follows:

Round 1: 4ch (counts as 1tr, 1ch), miss 1tr, 1tr into next tr, miss 2tr, 5tr into next tr, miss 2tr, *1tr into next tr, 1ch, miss 1tr, 1tr into next tr, miss 2tr, 5tr into next tr, miss 2tr rep from * to end, sl st into 3rd of 4th ch at beg of round.

Change to colour A.

Round 2: 4ch (counts as 1tr, 1ch), 1tr into next tr, miss 2tr, 5tr into next tr, miss 2tr *1tr into next tr, 1ch, 1tr into next tr, miss 2tr, 5tr into next tr, miss 2tr, rep from * to end, sl st into 3rd of 4th ch at beg of round.

Change to colour B and work round 2 of pattern.

Change to colour C and work round 2 of pattern.

Cont working round 2 and keeping a five-colour stripe until you have worked 19 rows of pattern.

Change to colour D.

Next round: 4ch (counts as 1tr, 1ch), 1tr into next tr, 2ch, miss 2tr, 1dc into next tr, 2ch, *miss 2tr, 1tr into next tr, 1ch, 1tr into next tr, 2ch, miss 2tr, 1dc into next tr, 2ch, miss 2tr, rep from * to end, sl st into 3rd of 4th ch at beg of round.

Change to colour E.

Next round: 1ch, 1dc into each st to end, sl st into first dc. 64dc
Work 1 more row of dc into colour E.

Change to colour A and work 1 row of dc as last round.

Next round: 1ch, 1dc into each of next 8dc, make 50ch, miss 16dc, 1dc into each of next 16dc, make 50ch, miss 16dc, 1dc into each of next 8dc, sl st into first dc.

Change to colour B.

Next round: 1ch, 1dc into each of next 8dc, 1dc into each of next 50ch, 1dc into each of next 16dc, 1dc into each of next 50ch, 1dc into each of next 8dc, sl st into first dc.

Change to colour C.

Work 1 row of dc all the way round the edge, sl st into first dc.

MAKING UP

Fasten off.

Sew in all loose ends. 



SKILL LEVEL



INTERMEDIATE



SUPER-SQUIDGY OCTOPUS!

Our amazing, funny, cuddly octopus
is designed to make you smile!

By Angela Turner



WorldMags.net

Pattern info

“We absolutely love the clever bobble stitch detail on the tentacles of this octopus - they look so real!”



**BENEDICT,
DESIGNER**

Materials

- ✦ Yarn
 - 3 x 100g DMC Natura XL Super Chunky in Teal (71)
 - 3 x 100g DMC Natura XL Super Chunky in Rose (42)
 - 1 x 100g DMC Natura XL Super Chunky in Black (02)
 - 1 x 100g DMC Natura XL Super Chunky in White (01)
 - 1 x 100g DMC Natura XL super chunky in turquoise (shade 07)
- ✦ Needles
 - 1 pair of 6.5mm (UK 3, US 10½)

BODY

Using Teal, cast on 12 sts.

First row: Purl.

Next row: Inc in every st. 24 sts

Next row: Purl.

- ✦ Extras
 - Stitch holders

Yarn detail

- ✦ DMC Natura XL Super Chunky Just Cotton
 - www.dmccreative.co.uk
- ✦ 100% cotton
- ✦ 100g/75m or 82 yds
- ✦ Machine washable at 30°C
- ✦ £4.89

Tension

13 sts and 17 rows to 10cm or 4in over st st using 6.5mm needles

Finished size

Circumference: 67cm or 26½in at widest point

Length of arm: 36cm or 14¼in

Special abbreviations

inc	increase(ing)
K	knit
k2tog	knit two stitches together
k3tog	knit three stitches together
P	purl
p2tog	purl two stitches together
p3tog	purl three stitches together
rep	repeat
st(s)	stitch(es)

Next row: (K1, inc in next st) to end. 36 sts

Next row: Purl.

Change to Turquoise.

Next row: (K2, inc in next st) to



SO CUTE!

If you like to have fun when knitting and love a showstopper, this sensational octopus project could be for you

end. 48 sts

Next row: Purl.

Change to Teal.

Next row: (K3, inc in next st) to end. 60 sts

Next row: Purl.

Change to Turquoise.

Next row: (K4, inc in next st) to end. 72 sts

Next row: Purl.

Change to Teal and st st 2 rows.

Change to Turquoise.

Next row: (K5, inc in next st) to end. 84 sts

Next row: Purl.

Keeping stripe patt correct throughout, st st 10 rows.

Next row: (K5, k2tog) to end. 72 sts

Work 7 rows st st.

Next row: (K4, k2tog) to end. 60 sts

Work 5 rows st st.

Next row: (K3, k2tog) to end. 48 sts

Work 5 rows st st.

Next row: (K2, k2tog) to end. 36 sts

Work 3 rows st st.

Next row: (K1, k2tog) to end. 24 st

Next row: Purl.

Cast off.

Sew seam, taking care to match stripes. Turn right side out and stuff with filling, a little at a time.

BASE

Using Rose, cast on 8 sts.

First row: Purl.

Next row: Inc in every st. 16 sts

Next row: Purl.

Next row: Inc in every st. 32 sts

Next row: Purl.

Next row: (K1, inc in next st) to end. 48 sts

Next row: Purl.

Next row: Knit.

Next row: *(P1, make mini bobble [(p1, k1 into the back of st, p1) into next st, transfer these 3 sts to left-hand needle then p3tog], p1) twice, turn.

Work on these 6 sts only.

Next row: Inc in first st, knit to last st, inc. 8 sts

Next row: Purl.

Next row: Knit.

Next row: (P2, make mini bobble) twice, p2.

Next row: Knit.

Rep last 4 rows 10 times.

Next row: Purl.

Next row: Knit.

Next row: P2tog, make mini bobble, p2tog, make mini bobble, p2tog. 5 sts

Next row: Knit.

Next row: Purl.

Next row: Knit.

Next row: P1, make mini bobble, p1, make mini bobble, p1.

Rep last 4 rows twice.

Next row: P2tog, p1, p2tog. 3 sts

Next row: K3tog.

Cut yarn and thread through.

Rejoin yarn to next 6 sts and rep from *. Rep till all eight arm bases have been made.

Gather round cast-on sts and pull up tightly. Sew seam to start of arm bases.

ARMS (MAKE 8)

Using Teal, cast on 4 sts.

First row: Purl.



Use our octopus to kick start an under-the-sea theme for a child's room

Next row: K1, (inc in next st) twice, k1. 6 sts
Beg with a purl row, st st 3 rows.

Next row: K2, (inc in next st) twice, k2. 8 sts
Beg with a purl row, st st 5 rows.

Next row: K3, (inc in next st) twice, k3. 10 sts

Beg with a purl row, st st 49 rows.

Next row: K3, k2tog twice, k3. 8 sts

Next row: P3, p2tog, p3. 7 sts
Cast off.

With right-sides facing, sew arm pieces together. Turn each arm right-side out and stuff with filling,



It's true, with the right outfit this cuddly child's toy can also double as very attractive headwear. Worn with the right shoes of course!



not too firmly. Once all arms are stuffed, place body on top of arm base and sew the tops of arms to the cast off sts of body, adding some filling as you go. Ensure all loose ends are tied in securely.

EYES (MAKE 2)

Using black, cast on 6 sts.
Change to White.

First row: Purl.

Next row: Inc in every st.
12 sts

Next row: Purl.

Next row: (K1, inc in next st) to end. 18 sts

Next row: Purl.

Next row: Knit.

Next row: Purl.

Next row: (K1, k2tog) to end.
12 sts

Next row: P2tog to end. 6 sts

Cut yarn and thread through. Gather round cast on sts and pull up tightly. Sew seam, leaving a gap for filling. Turn right side out and stuff firmly. Sew remaining gap. Place eyes on body, with centre of each eye about ten rows up from cast off edge and with about a 0.5cm gap between them.

EYELIDS (MAKE 2)

Using Teal, cast on 14 sts.

First row: Knit.

Next row: K2tog, knit to last 2 sts, k2tog. 12 sts

Next row: P2tog, purl to last 2 sts, p2tog. 10 sts

Rep last 2 rows again. 6 sts

Cast off.

Place eyelids on top of eyes and sew in place securely to finish. 



NaturaXL
Just Cotton

Think Big!



Because
size matters...

Natura XL will be your perfect
super chunky yarn to create big, bold
crochet and knitting projects in quick time.



@dmccreativeworld www.facebook.com/dmccreative dmccreativeworld

To find out your nearest retailer and how to use it visit our website
www.dmccreative.co.uk Tel: 0116 275 4000 email: consumer@dmccreative.co.uk